





*Dash says: "Theres a lot to digest, but I hope I've been able to help simplify things a little"*

Draft



# Access for All

**A Guide to Making Public Areas  
and Services Accessible to Everyone**



## Statutory and Policy Context

**Access for All** has been produced as a Supplementary Planning Document [SPD]. It has been informed by community involvement and is accompanied by a Sustainability Appraisal [SA], which also provides the necessary background regarding the social, environmental and economic considerations which have been applied throughout the production of this document. It is in line with Harrow's vision to create a borough that is fully accessible by sustainable means, in terms of both the built environment and local service provision. The SPD has been written to reflect and supplement Policies D4, C16 and C17, and will also contribute towards the implementation of policies SR2, SC1, EP47, D25, C7, and C9, of Harrow's Unitary Development Plan (HUDP), formally adopted on 30th July 2004.

**Access for All** was the subject of a 6-week public consultation programme and was formally adopted by Harrow Council on XX XXXXXXXX XXXX to form part of the Local Development Framework (which will eventually replace the HUDP). Its guidance can be taken into account as a material consideration, when determining the outcome of Planning Applications.

Planning applicants should also refer to the Greater London Authority's Supplementary Planning Guidance 'Accessible London: Achieving an Inclusive Environment', published in April 2004.

## **Written and produced by**

Ali Kashmiri - Access Officer, Harrow Council, London

## **Acknowledgements**

With thanks to:-

Paul Jarman - Assistant

Claire Spraggs - Assistant

Keith Farmborough - Graphic Designer

Phil Greenwood - Group Planner

Sukhpreet Khull - Policy planner

Robert King - Photographic Support

Daniel Trevors - Charactor Creator (Dash)

Uluma Egenamba - Assistant Planner

Jacqueline Lockyer - NRAC Accredited Consultant

for their assistance.

# Contents

Page No.

<b>Foreword</b> .....	1
<b>Introduction</b> .....	2
<b>Inclusive Design</b> .....	3
Principles - Benefits .....	3
<b>Access Statements</b> .....	5
<b>Access Legislation</b> .....	7
Disability Discrimination Act; 1995 .....	7
Part M to the Building Regulations; 2004 .....	7
British Standard 8300; 2001 .....	8
<b>Buildings Surroundings and Access Routes</b> .....	9
<b>Accessible Parking</b> .....	11
Design of Parking Bays .....	11
Location of Parking Bays .....	11
Parking Control Equipment .....	13
<b>Alteration or 'Change of Use' Planning Applications</b> .....	14
<b>Entry into a Building</b> .....	17
Alternative to Level Entry .....	19
<b>Design of Lobbies</b> .....	21

# Contents

Page No.

<b>Reception Areas</b> .....	23
<b>Moving Around a Building</b> .....	26
Internal Doors .....	26
Steps and Stairs .....	27
Corridors .....	28
Lifts .....	28
Public Toilets .....	29
<b>Signage and Wayfinding</b> .....	32
Text & Language .....	32
Characters .....	32
Positioning .....	33
Colour .....	33
Lighting for Signs .....	34
Specific Features .....	34
Audible Signs .....	36
<b>Fixtures and Fittings</b> .....	37
Door Furniture .....	37
Lighting, Equipment, Controls and Switches .....	38
Colour .....	39
<b>Eating and Drinking Areas</b> .....	40
Layout .....	40
Café Culture .....	42

# Contents

Page No.

<b>Leisure and Entertainment</b> .....	43
Parks and Open Spaces .....	43
Playgrounds and Children's Play Areas .....	46
Keep Fit Areas and Gyms .....	47
Swimming Pools and Leisure Pools .....	48
Pool Lifts .....	50
Spectator Seating and Viewing .....	51
Community Centres .....	53
<b>Places of Worship</b> .....	54
<b>Buildings of Special Architectural or Historic Interest</b> .....	55
<b>Education and Learning Establishments</b> .....	57
Libraries .....	58
<b>Overnight Accommodation</b> .....	60
Bedrooms .....	60
Bathrooms .....	62
<b>Emergency Provisions and Means of Escape</b> .....	63
Providing Accessible Alert & Escape .....	63
Refuge Areas .....	63
Evacuation by Stairs .....	64
Procedures and Training .....	64
Evacuation Responsibility .....	65



# Contents

Page No.

<b>Communicating and Accessing Services</b>	66
Talking with Customers .....	66
Tips for Communicating .....	67
Product or Service Information .....	68
Ways of Communicating .....	69
Video Linked Lip Speaking and Signing .....	69
Hearing Enhancement Systems .....	69
Text Phone & Typetalk Services .....	70
Public Telephones .....	70
Cashpoint Machines .....	71
Electronic Information Points .....	71
Accessible Information .....	72
Accessing the Internet .....	72
Accessible Websites .....	73
<b>Sources and References</b> .....	74

# Foreword

It is often the finer points of access that are forgotten in the development process. The intention of this guide is to encourage designers and developers to anticipate and overcome restrictions that prevent people from making full use of a building, the facilities and surroundings. It is also the aim of this guide to promote standards of access which reach above and beyond the minimum requirements of legislation, by fully integrating 'best practice' solutions into the design and planning process.

Building on its commitment to promoting an environment from which no one is excluded, Harrow Council is harnessing the creative attributes of all professionals involved in the design and implementation of new developments.

With deliberate, persistent effort and teamwork, an accessible environment that is truly inclusive, can become a reality for the whole community of Harrow.



Andy Parsons  
Group Manager, Planning & Development

A handwritten signature in purple ink that reads "Andy Parsons". The signature is written in a cursive, flowing style.

# Introduction



Most people, at some stage during their life will experience some form of mobility impairment. This may occur during pregnancy, after an accident or period of ill health, when we are children, as a result of temporary or permanent disability, or simply as we get older. In fact, there are over 9 million people with some form of impairment living in the UK today. They are approximately 15% of the total population. It is worth remembering that a good environment for disabled people is a great place for everyone.

The introduction of new legislation has increased people's awareness and obligation to create environments that are user friendly and designed to welcome everyone, of any age, size and ability. The aim of this Guide, is to assist in reducing the number of 'no-go' buildings and inaccessible facilities and services within the borough.

To assist applicants in the swift processing of planning and building regulation applications, developers should be aware, from the beginning, of the criteria used for planning accessible environments. Harrow Council actively welcomes your early consultation with the Planning Department as inclusivity is key to meeting planning requirements.

These guidelines have been prepared to illustrate some possible answers to the questions most frequently asked and relate to both new and existing developments. We are fully committed to creating an environment that is free of physical barriers and we are looking forward to a new era of co-operation between designers, planners and developers, who will fully embrace the principle and spirit of 'Access for All'.





# Access Statements



An Access Statement is a document illustrating what has been done from the start to ensure buildings, services and facilities are accessible to disabled and non-disabled people alike.

Access Statements are now central to the Planning Application process and Harrow Council is empowered to formally address detailed access issues as a key principle for granting permission. Designers, developers and clients are now obliged to provide statements covering the finer details of access as part of the overall design process.

An Access statement could begin life as a one-sentence explanation that demonstrates a commitment to incorporate the principles of inclusive design at every level. It is a live

document that changes and grows as the development progresses. It seeks to ensure that access is, and remains, inclusive to a development and not merely ancillary to its existence or the services it provides. (Also see section Communicating and Accessing Services, P66).

**At detailed Planning Application stage** - the Access Statement will need to demonstrate how compliance with BS 8300 2001, and Part M to the Building Regulations 2004 will be achieved. Familiarity with, and inclusion of relevant parts of the Disability Discrimination Act 1995 should also be demonstrated.

**At Building Control stage** - the statement may need to be expanded further to demonstrate the finer detail of access provisions.

**At building completion stage** - the Access Statement should form part of the establishments' operational procedures, providing management personnel with sufficient background, to ensure that all accessibility features remain in place throughout the life of the building.

Access Statements must be submitted with a planning application to avoid unnecessary delays or rejection of an application.

The precise details of an Access Statement will vary according to the type of project. Regardless, each statement should identify the:-

- philosophy and approach to inclusive design
- key issues of the scheme
- sources of advice and guidance used.

Further information about writing an Access Statement can be obtained from Harrow Council's Development Control Department.

# Access Legislation



## **Disability Discrimination Act 1995 (Amended by the DDA 2005)**

The Disability Discrimination Act 1995 (DDA) has been phased in over several years. The initial legislation introduced measures to ensure that disabled people received the same level of service, whilst also making it unlawful to continue discriminatory practices in workplace environments. It is now also unlawful to prevent disabled people from using a service on the grounds of impairment alone.

All service providers, ranging from banks to bakeries, are now required to make reasonable adjustments to services to enable disabled people to gain equal access to the service. Service providers must also remove physical barriers by taking measures to alter any physical feature, which prevents disabled people from making

full use of those facilities. Modifications to premises often involve relatively low-cost changes and can be introduced with minimal inconvenience to 'business as usual'.

The legislation concerning the removal of physical barriers came into force on 1 October 2004. All service providers have a duty to anticipate the access requirements of disabled people and to make suitable adjustments to facilitate independent access. Failure to take reasonable steps to facilitate access, whilst not necessarily actionable in itself, can aid a case for discrimination against the service provider concerned.



## **Part M to the Building Regulations**

This legislation introduces improvements to the physical features of new developments and buildings where major alterations are desired. It also incorporates into the design of public buildings, the access requirements of people with sensory impairments.

## **British Standard 8300: 2001 - Code of Practice**

British Standard 8300 is a source of 'best practice' focusing on the design of buildings and their approaches to meet the needs of disabled people. It has been introduced to assist architects, town planners, builders, surveyors and facilities managers with implementing innovative design solutions in meeting the requirements arising out of the Disability Discrimination Act.

# Buildings Surroundings and Access Routes

The council will require access roads or pedestrian routes, provided as part of any development, to promote, a safe, continuous and barrier free passage from the pavement or parking area to the main entrance of a building. This design approach enables people with visual impairments to predict and anticipate obstacles.

Separate, non-integrated access routes for disabled people are unacceptable and must be avoided. Where an alternative route is necessary for the purposes of by-passing a physical barrier such as a flight of steps or a ramp, the route must remain close by and form part of the integral design of the scheme as a whole.

Access routes for pedestrians should be designed in accordance with BS 8300 to include:-

- a designated clear corridor which has at least 1200mm of unobstructed clearance between items of street furniture
  - smooth and level paving particularly avoiding the use of gravel or loose chippings on paths
  - 'warnings underfoot' (textured paving), or warnings that can be detected during the sweep of a cane, thereby reducing the risk of visually impaired people colliding with unavoidable obstacles along the way
  - dropped kerbs at intersections, seamlessly adjoining with the road or surface level, at least 1.4 metres wide and not steeper than 1 in 12
  - drainage gratings, grid and inspection covers that are flush with adjacent surfaces
- tactile paving to be provided at all crossing points

- clearly distinguish traffic routes including cycle paths by a change of level and texture, as appropriate
- at least 2100mm height from the pavement to any overhead protrusion from a building
- clearly contrasted street furniture, making it more obvious to visually impaired people
- avoid free standing advertising such as 'A' boards within pedestrian circulation areas
- positioning any necessary bollards at 1m high, 900mm apart and without chain links
- lighting to a minimum of 100 lux.



# Accessible Parking

## Design of Parking Bays

Parking bays for disabled people should be designed to ensure that sufficient space to the side and rear of the vehicle is provided, to allow wheelchair users unobstructed access to the side and rear of their vehicle, whilst being protected from other traffic.

## Location of Parking Bays

Whether on or off-street, accessible parking bays should be located close to popular facilities such as banks, post offices, large stores and supermarkets.

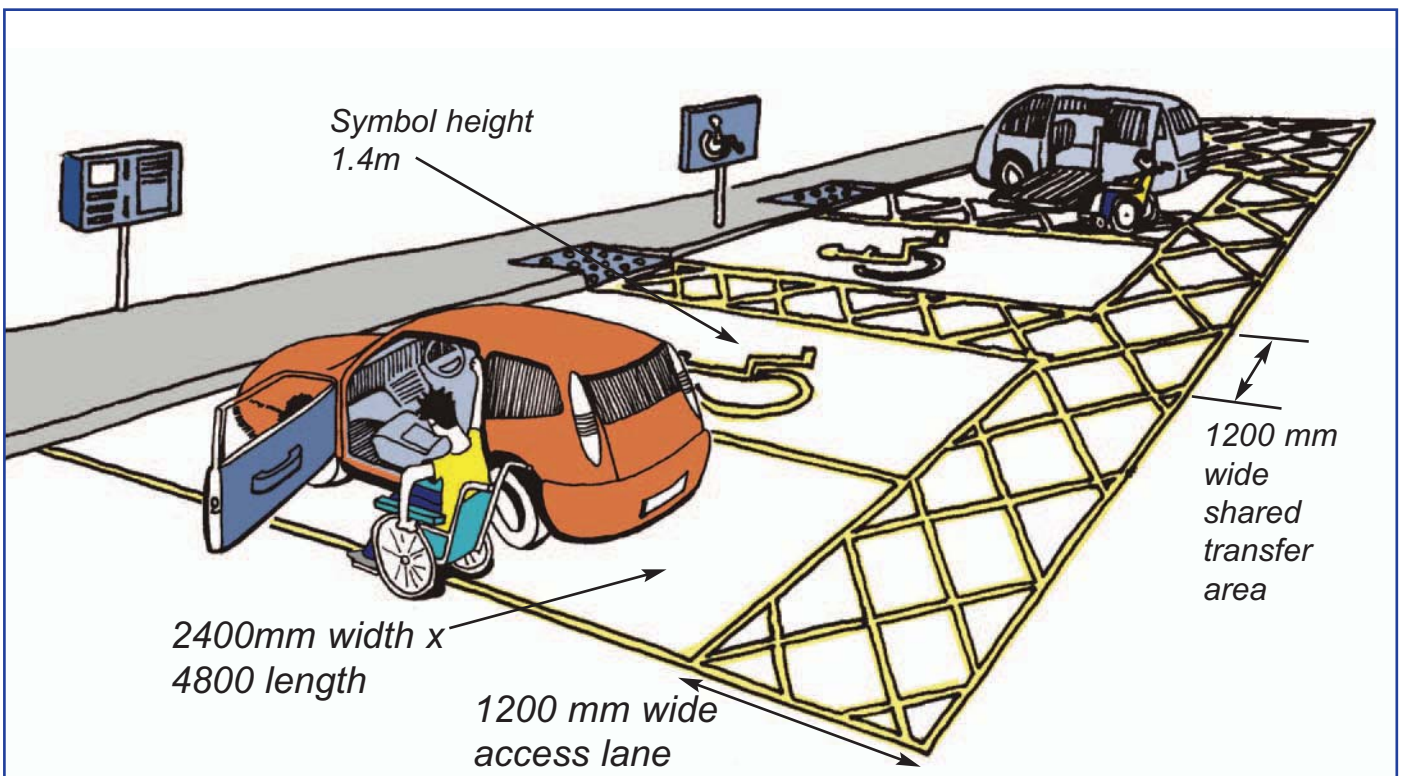

Accessible Vehicle Parking should be designed to BS 8300 and should:-

- be located within 50m of the entrance, where parking is designated to a particular building
- be designated 1 in 20 of total available parking spaces
- be clearly signed to be visible from the car park entrance
- be on level and firm ground
- be under cover where possible
- clearly indicate payment arrangements for blue badge permit holders
- have a dropped kerb provided nearby for access to the pavement, as appropriate
- provide a clearly identifiable, safe and straightforward access route, from the car park to the building.

## Parking Control Equipment

Parking meters, pay and display ticket machines and barrier controls should be designed in accordance with BS 8300 and should be:-

- at a suitable height for disabled users to see and use (between 1000mm and 1400mm above surrounding ground)
- mounted on the ground (no plinth or step) and easily reachable
- installed according to specification set out in British Standard BS 6571-4: 1989.

When use of barrier control equipment is necessary to enter a car park (where a ticket or token has to be taken from the machine by the motorists using their car), alternative arrangements should exist to allow drivers with limited or no reaching ability, to gain access to the car park.



Displaying a car park management telephone number or subscription to the National Service Call service, will assist in instances of difficulty.

# Alterations or ‘Change of Use’ Planning Applications

Harrow Council will expect to see appropriate access improvements as part of planning applications relating to new buildings, material alterations and material changes of use. Access improvements for the alteration of existing buildings should be in keeping with the principles of BS 8300 and could include:-

- improvements to approaches, e.g. paths and paving
- use of ramps, stairs, platform lifts that are fitted with handrails, to overcome stepped level differences
- appropriate fixing of handrails
- introduction of improved lighting, widening of doors, and slip resistant and glare free flooring
- the introduction of minor changes such as alteration or replacement of door handles, position or direction of door openings and positioning of light switches
- improvements to reception areas
- introduction of accessible toilet facilities
- installation of equipment to enable or enhance communication
- use of touch, sound, fragrance and air movement, to assist those with visual impairment, in locating and navigating
- improved signage
- introducing colour or tonal contrast between features, e.g. door frames, walls, skirting panels, floors, furniture or equipment, etc
- improvements to fire and emergency egress provisions, including management procedures.



## Retail Units

A significant proportion of shop units in Harrow are inaccessible to disabled people, mainly because of the difference in level between the pavement and the shop floor. The Council will therefore require all retail outlets undergoing refurbishment, (particularly where a new shop front is to be installed) to provide level or suitably ramped access.

In considering planning applications, the Council will invoke its discretion and judge each case individually.

Illustrative examples of how access can be achieved are detailed as follows:-



Option 1:- Accessible threshold

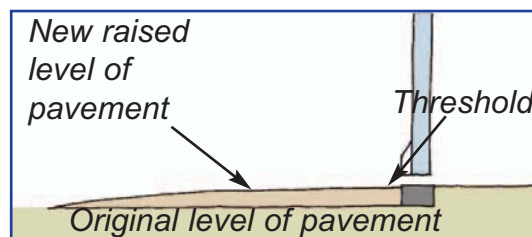

Previous stepped entrance



Accessible entrance



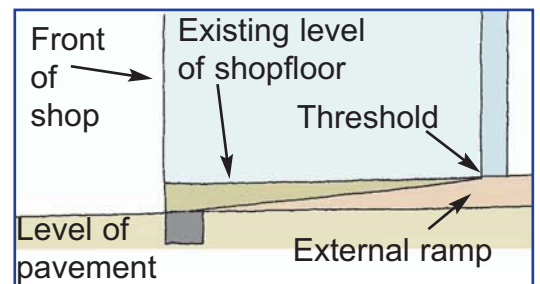

Option 2:- Accessible shop entrance achieved by recessed door & external ramp

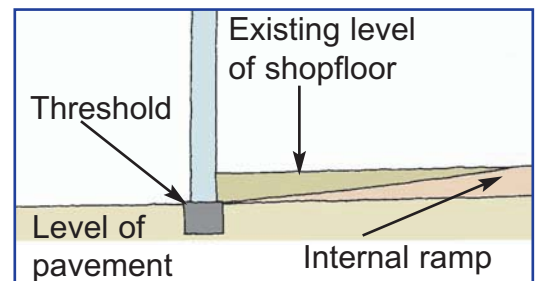

Option 3:- Accessible shop entrance achieved by lowering a section of internal floor

## Entry into a Building

Regardless of type of application and whether or not building works are proposed, the Council will require all applicants to ensure that level or suitably ramped entrance access is provided. In new buildings level access is preferable.

Introducing access improvements need not be difficult or expensive, and Access improvements may be funded by the business establishment, or where appropriate, considered as part of any on-going highways improvement programme.

Alterations to entrances should be designed in keeping with the principles of BS 8300 and could include:-

- making the entrance obvious and easy to use with building number and name between a height of 900 and 1400mm
- being level with the pavement
- ramping the internal or external ground surfaces to the same level as the pavement
- being fitted with sliding automatic doors, or a door that can be opened by means of operating a control switch, avoiding turnstiles, revolving and swing doors
- doors with vision panels, between a height of 900mm and 1500mm from the ground
- manifestation (suitable permanent marking) to fully glazed doors, between a height of 850mm to 1000mm and 1400mm to 1600mm from the ground
- a clear opening door width of not less than 830mm
- doormats which are sufficiently recessed to minimise tripping hazards and which do not impede the free movement of people with buggies or using wheelchairs

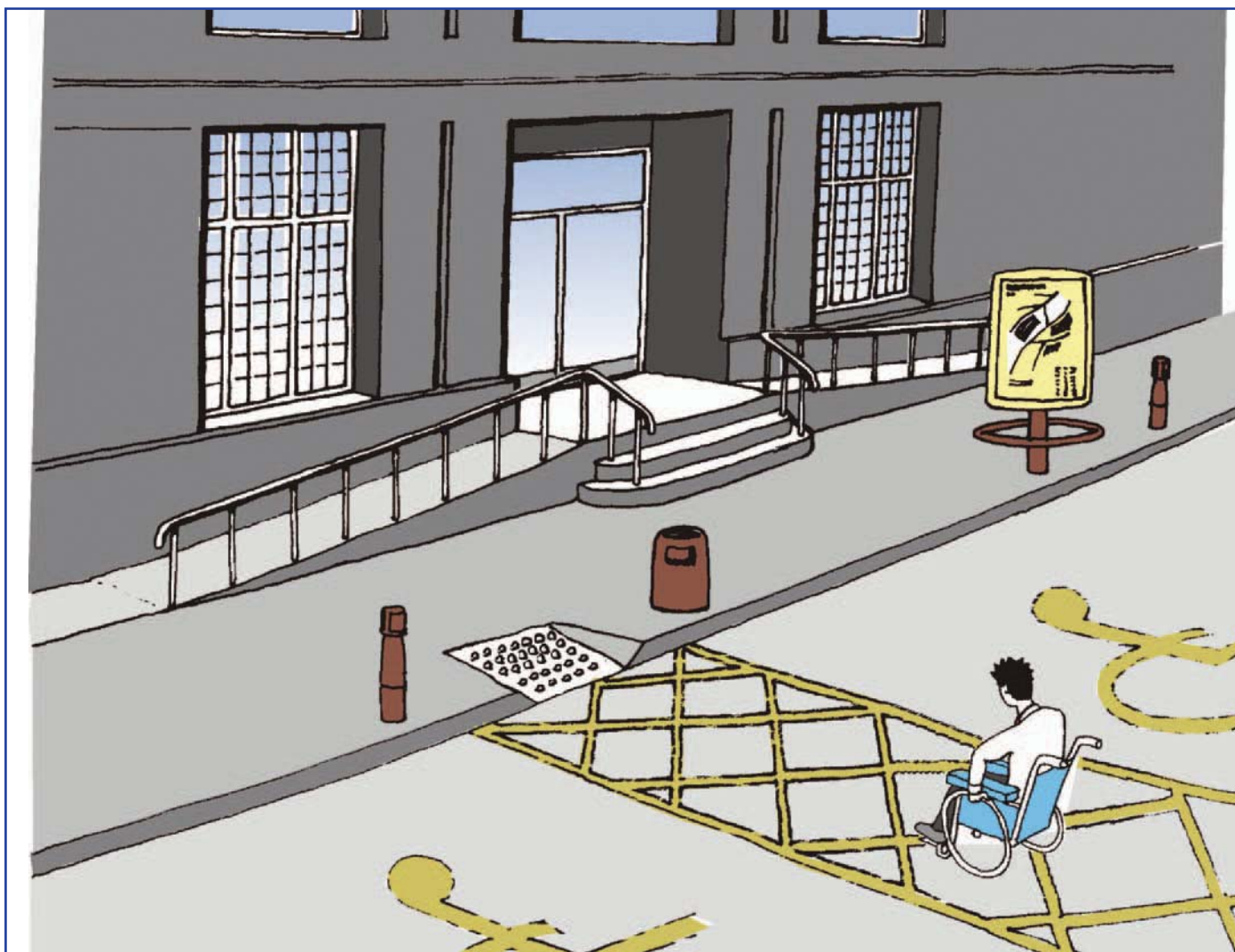

- avoiding coir matting (difficult for wheelchair or stick users to negotiate)
- providing the leading edge (door handle side edge) of the door with an adjacent clear space of at least 300mm
- allowing for easy and regular adjustment of closers on manually operated doors, so that the minimum force needed to open the door can be maintained.



## Alternative to Level Entry

There will be instances particularly when improving access into existing buildings where level entry may not be achievable. Where it becomes necessary to incorporate alternative access arrangements into a scheme, it is important to:-

- warn people, particularly people who are visually impaired, that they are approaching a flight of steps with tactile surfacing and colour contrasting stair tread nosings
- ensure that the access ramp is designed in line with Part M to the Building Regulations and that its location is easily identifiable, particularly to first time visitors.

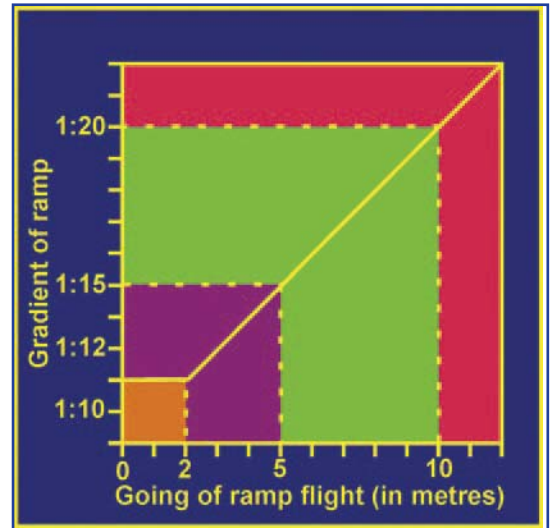

*The relationship between the Ramp Length and Gradient*

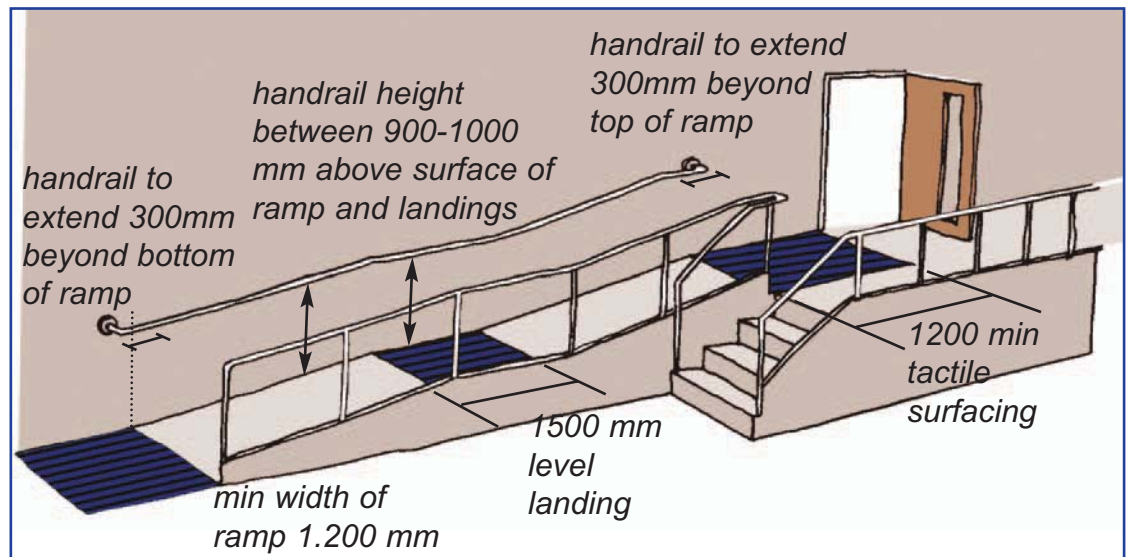
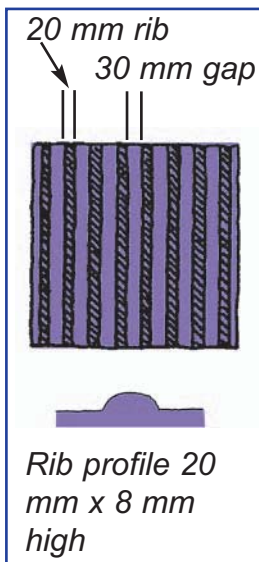



## Design of Lobbies

Lobbies can be major obstacles to access, particularly for wheelchair users if they are not designed correctly. In order for a lobby to be user friendly, the design should follow guidance laid out in BS 8300 and should:-

- have automatic sliding or power assisted swing doors
- provide space for a person assisting, to open a door and easily assist a wheelchair user through
- not have glazing which creates distracting reflections
- have guardrails or other hazard protection, in contrasting colour and luminance, where columns, ducts and other elements project more than 100mm into the access route within a lobby.

### *Key Dimensions for Lobbies with Internal and Externally Opening Doors*

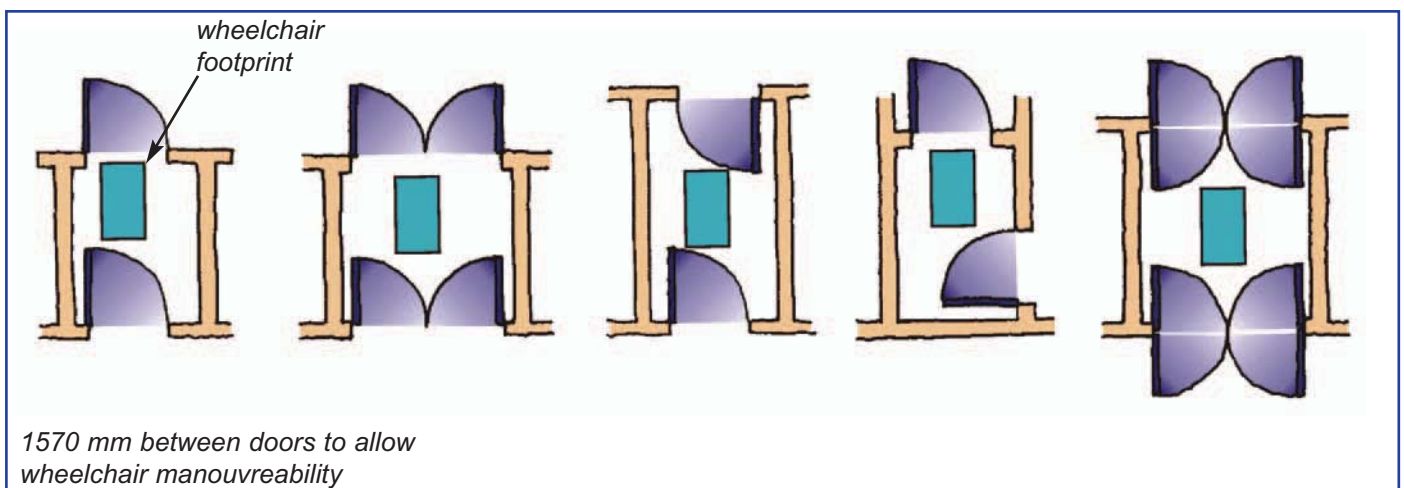

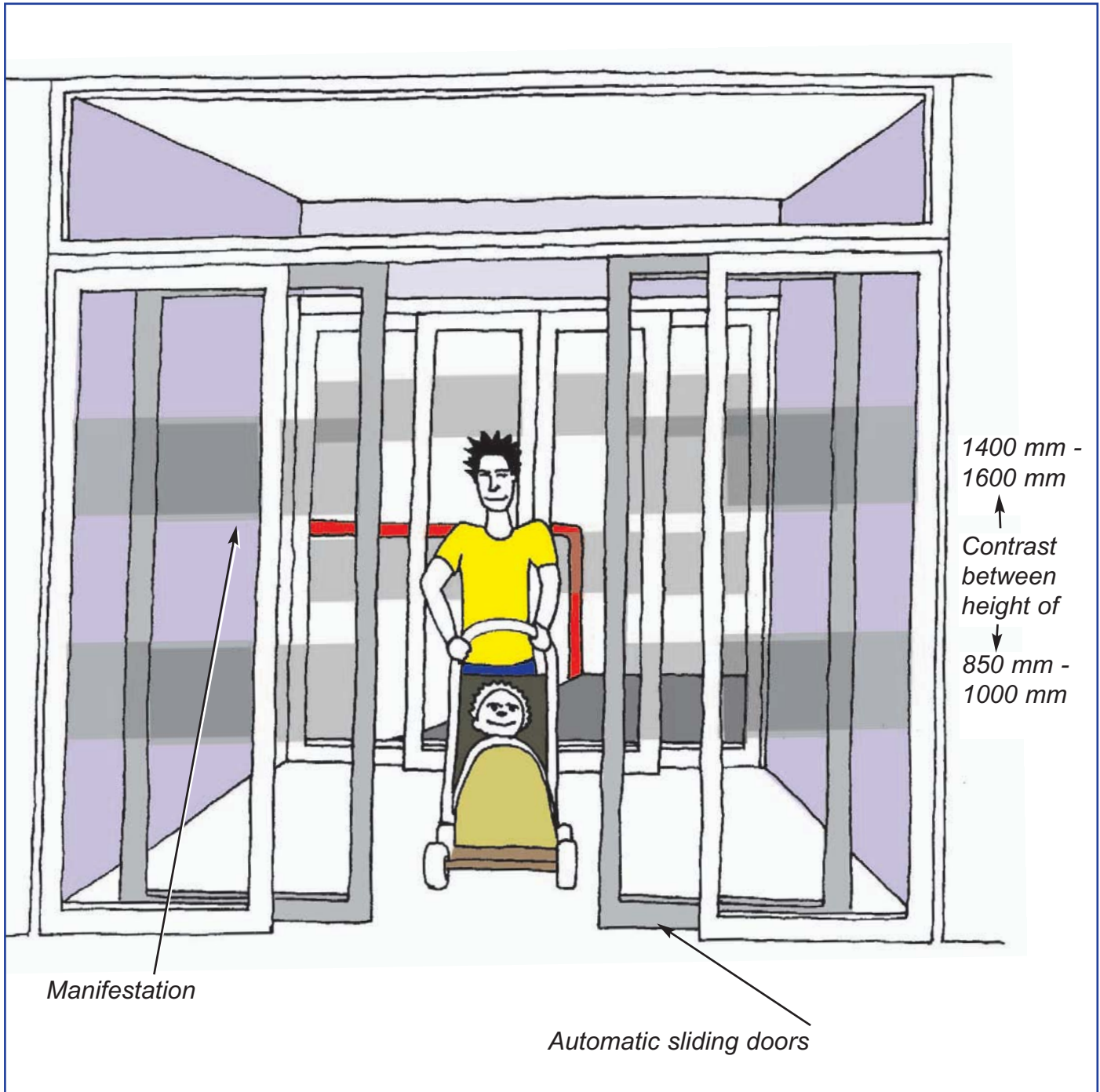

# Reception Areas

Whilst Reception areas are usually designed to be warm and welcoming, accessible features are often forgotten.

When we consider people and their abilities as a primary design objective, we can begin to adopt a more coherent and systematic approach in promoting environments and services that are welcoming.

Reception features should be designed in accordance with BS 8300 and should include:-

- signage which is clear, concise, with consistent use of terminology, providing stark contrast in colour between text and background
- clearly defined, well lit, unobstructed routes to reception counters, lifts, stairs and WCs, with plenty of circulation space
- suitable protection against protruding door space, e.g. recessed door or handrails
- suitable warning signs which alert visitors to outward opening doors
- areas that are quiet and well lit, to assist hearing impaired people with communication
- spaces for wheelchair users in waiting areas, which are integrated into the seating arrangements
- seating at varied heights, with and without arm rests as the preferred option
- telephones which are located where background noise is minimal, fitted with accessible features (e.g. large number keypads and technology to assist hearing aid users, at a height that allows wheelchair users to read any visual display panels and to use the telephone with ease) and a pull-down seat should also be provided



- a hearing enhancement system as a permanent feature, particularly where the customer is separated from the service provider by a glazed screen (see section on Hearing Enhancement Systems).
- have exposed edges well rounded
- provide access for wheelchair users both sides of the counter
- allow for sufficient counter space which facilitates people signing documents

Reception desks or counters should:-

- be set at a height suitable for seated and standing users with high and low sections where possible
- have an upstanding lip at the edge of the counter, which assists the user in picking up loose change or tickets
- have contrast between objects and surfaces with the top of the counter contrasting with the edge
- not be located in front of windows or reflected light, as this can result in silhouetting which prevents lip reading.



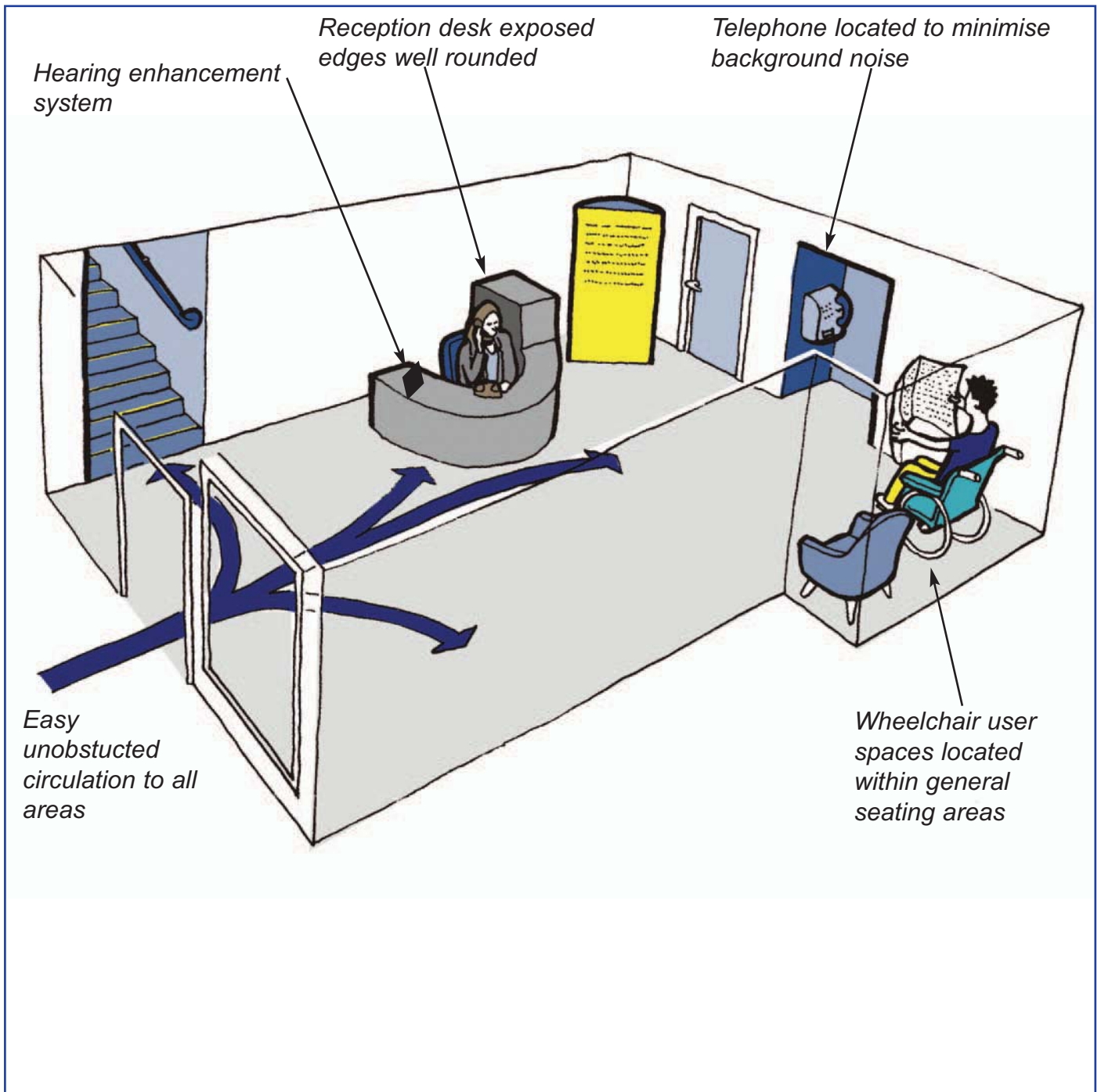

# Moving Around a Building

When consideration is being given to making a building accessible, it is important to consider the wider issues of access, not just points of entry and exit. When designing the internal features of buildings it is important to consider exactly **how** people are going to use the building and **all** its facilities.

The internal layout and features should be designed in line with Part M to the Building Regulations and BS 8300.

## Internal Doors

These should:-

- be at least 750mm wide, or 775mm where the door leads from a 1200mm corridor at a 90° angle

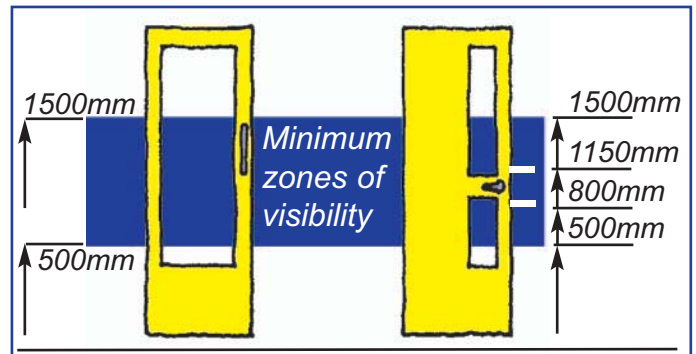
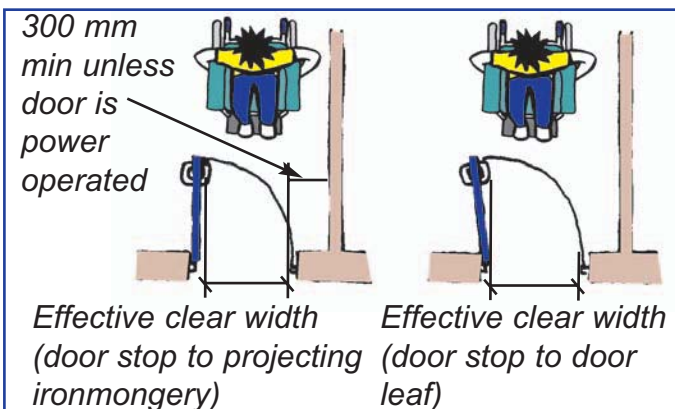

- be fitted with easily gripable lever door handles
- have a door closer which does not apply a pressure of more than 30 newtons (30 N from the closed position to 30° open, and not more than 22.5 N from 30° to 60° open)
- have 300mm to the side of the leading edge and contrast in colour and luminance with the remaining surfaces of the door and its surroundings
- have architrave which contrasts in colour and luminance with the wall surfaces surrounding the doorway
- contain vision panels at a height of 900mm to 1500mm, particularly when sited across a circulation route and where there is heavy pedestrian use.

## Steps and Stairs

Stairs should have:-

- warning surfaces to indicate a change in level on the approach to internal stairs
- nosings which are clearly contrasted in colour and luminance with the remaining stair area
- individual flights which do not rise more than 1.8 metres and which have resting places
- a clear width of 1000mm
- closed risers of 150mm to 170mm with tread/goings between 250mm to 300mm.

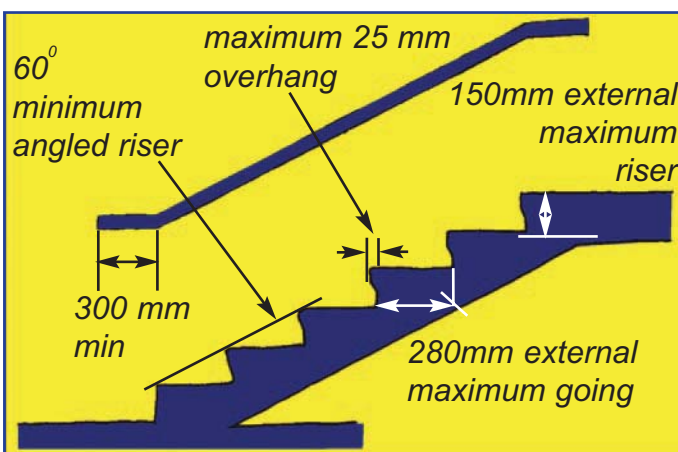
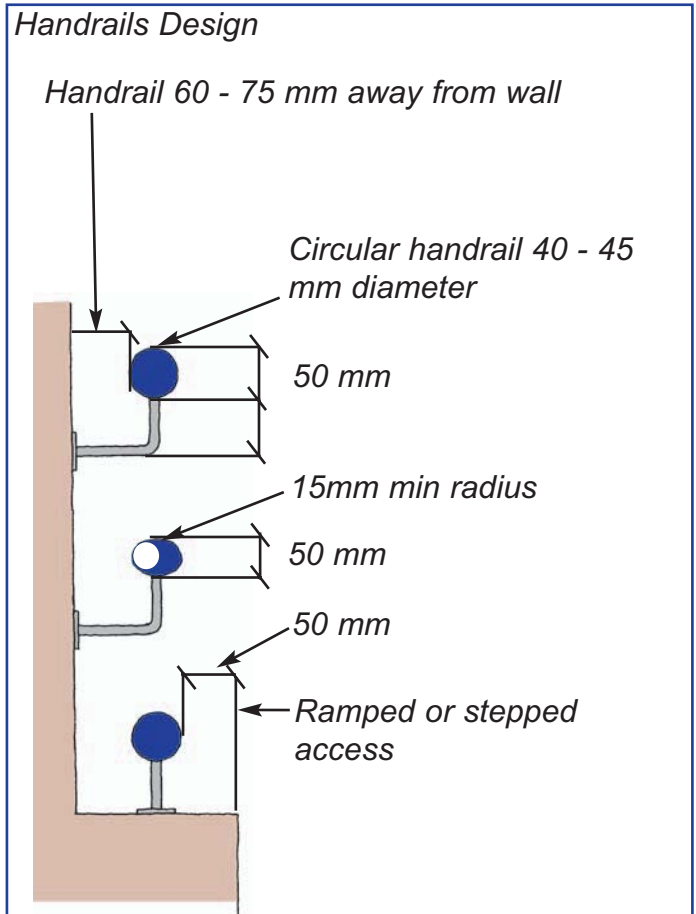

External Steps Design

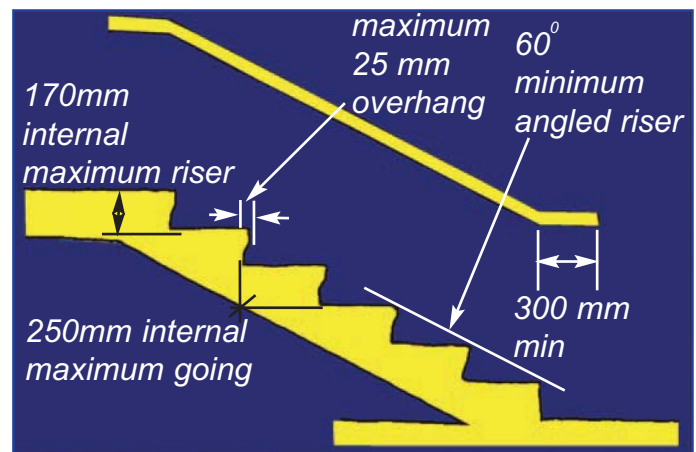

Internal Steps Design

## Corridors

Corridors should have:-

- a minimum clear width of 1200mm, with a 1500mm turning circle available at least every 10 metres
- passing places for wheelchairs, where the corridor width is increased to 1800mm at reasonable intervals and at corridor junctions
- recessed areas where radiators and safety equipment may be positioned
- diffused lighting which does not produce glare, reflection or shadow
- floor coverings that cannot be mistaken for steps, e.g. avoiding horizontal stripes
- a recess at least as deep as the width of the door leaf for any door that opens onto a corridor.

## Lifts

In line with BS 8300 lifts should have:-

- clear signage, visible from the building entrance, indicating the location of an accessible lift (see Signage & Wayfinding)
- a clear manoeuvring space of 1500mm x 1500mm in front of the entrance to all types of lifts
- landings illuminated to at least 100 lux

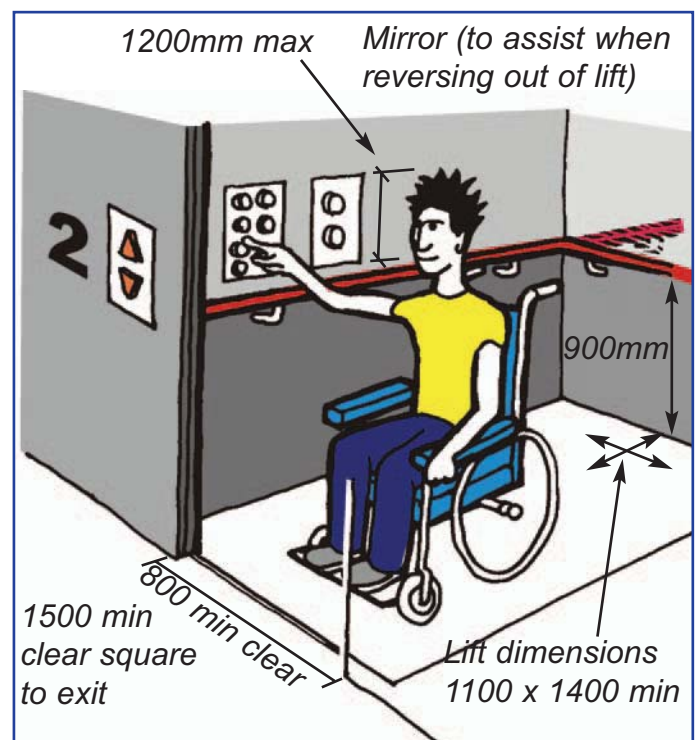



- seating in close proximity to the lift waiting area
- lift controls mounted between 900mm and 1100mm from floor level and at least 400mm from any return wall to allow reach by wheelchair users
- raised symbols on the control buttons to enable tactile reading
- audible announcements of lift arrival, direction of travel and level reached and where appropriate, services offered on that level
- a mirror on the back panel of the lift car, opposite the lift door, at a height of 900mm above floor level, in order to allow a wheelchair user to see behind them
- a sign indicating the floor level which can be easily seen from the lift car, or on exiting the lift.

## Public Toilets

Public Toilets should be provided for the use of visitors and staff. Access to public toilet facilities near the entrance

of a public area (such as a bar or restaurant) should be conveniently located and readily accessible to disabled people who use the facilities independently, and to those people who need assistance. Accessible toilet facilities should be adjacent to any other toilet facility provided and should be unisex, in order that the person needing support may be assisted by a member of the opposite sex.

Provisions could include:-

- slip resistant flooring
- both horizontal and vertical door pulls, to enable the door to be closed after entering
- locks to be of a lever action or similar type that are easy to use
- a combination of left and right hand transfer areas allowing access to toilet facilities
- washing and drying facilities that are both reachable when seated on the WC and easily accessible by wheelchair users

- fixtures and fittings that are clearly visible and contrast in colour with their background
- grab rails, handrails and drop-down rails that are plastic coated and easy to operate
- padded WC backrest
- strong and firmly fixed toilet seat (475 - 480mm above floor level) that will not move about during transfer
- automatic hand basin taps
- automatic flush mechanisms
- easy to grasp emergency cords that extend to the floor

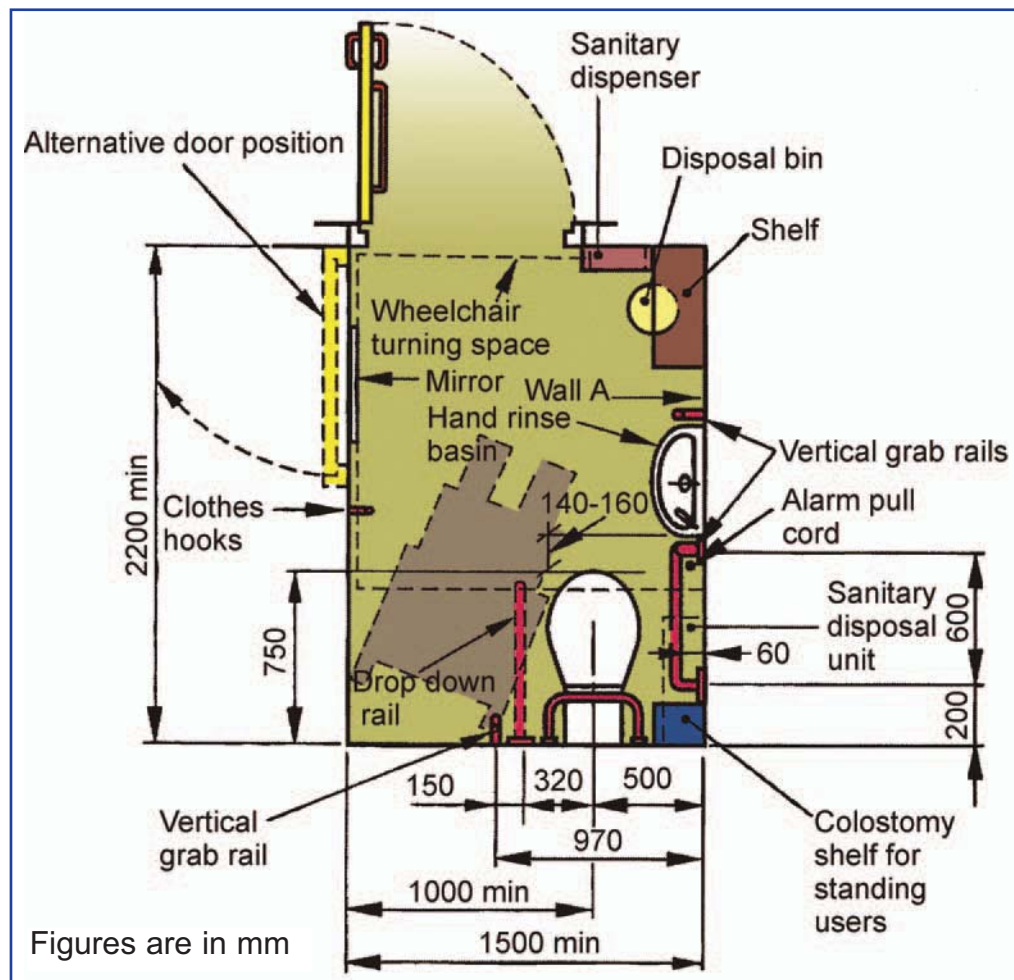

- dispensers that allow for easy one handed operation, e.g. toilet roll
- a 2-way, hands-free intercom system
- motion sensors for lighting
- fixed, full-length mirrors for use by both seated and standing users

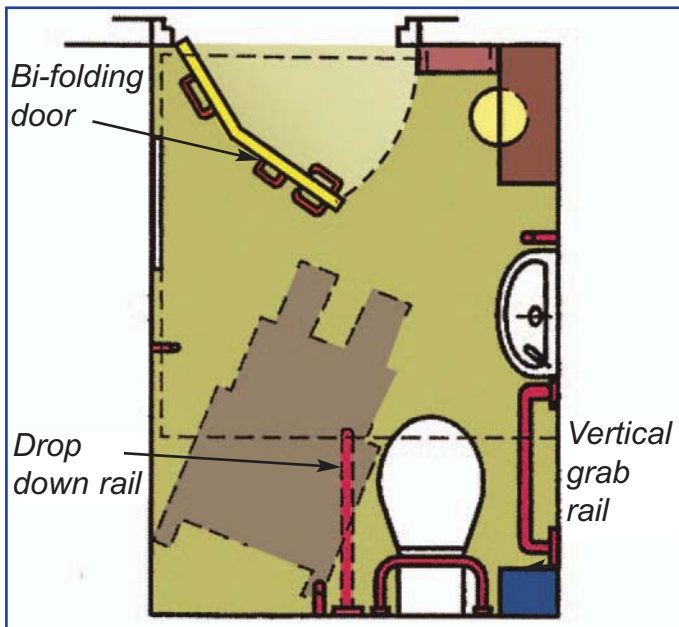

for use when an outward fitting door would be dangerous to passers by

- a shelf and rail on which to hang coats or place personal item, e.g. coats, handbags, mobile phones, shopping, etc
- recessed fittings/facilities such as waste bins, vending machines, radiators, etc
- pipes that do not block access or manoeuvring space
- emergency alarms that are audible and visual, that will provide immediate assistance

- sealed waste container for disposable items
- a full-length changing bench for adults
- height adjustable baby changing facilities
- electric hand dryer at appropriate level.

If provision is made for more than one toilet, left and right handed layouts should be provided. All toilet provisions should conform to the minimum requirements of BS 8300: 2001 and should be suitable for use by both staff and visitors.

Toilets should not be used for storage, thus taking up space intended for manoeuvring a wheelchair.

The internal layout and features should be designed in line with Part M to the Building Regulations and BS 8300.



# Signage and Wayfinding

Even well laid out buildings require signage which is clearly designed and positioned to enable building users to easily navigate. For people with little or no sight, visual signs are of little or no use.

An accessible signage system is one that can be seen, felt and heard, and should be regarded as an integral part of any design.

Signs should be designed in accordance with BS 8300 and should consider the following features:-

## Text & Language

This should:-

- use plain language
- be large, clear, legible and concise
- use symbols or pictograms in addition to written words
- be consistent with the use of terminology throughout the building

## Characters

Characters should be in accordance with BS8300 and should:-

- have a character size of 50-100mm, for medium range reading, e.g. identification signs in reception areas
- have a character size of 15-25mm, for close-up reading, e.g. wall mounted information signs

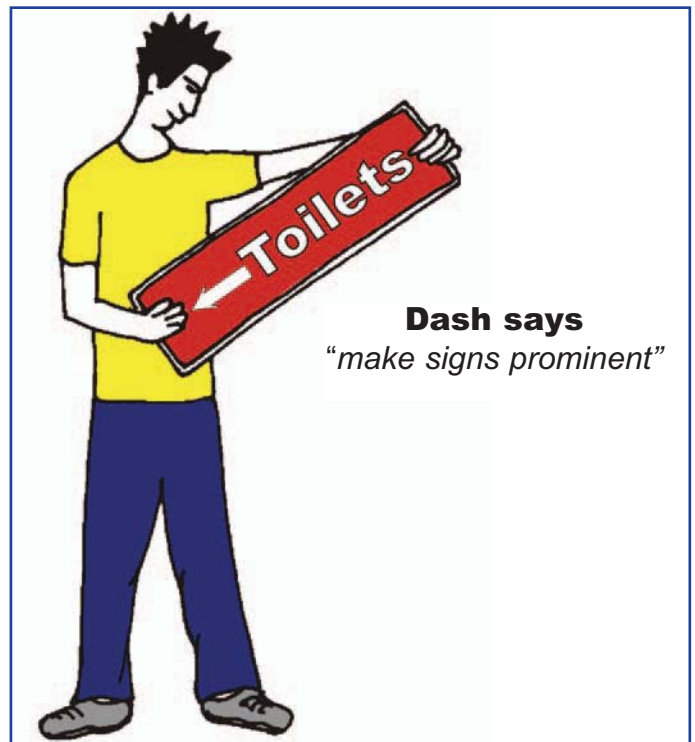

- be formatted using a character height between 15-50mm (as appropriate), with clearly defined rounded or chamfered edges, and a mix of both upper and lowercase lettering
- have a minimum character size of 150mm for external long distance reading, e.g. to identify a building entrance.

### Positioning

This should be in accordance with BS8300 and should:-

- be at the same height throughout a building, ideally within 1400mm-1700mm from the finished floor level, except for signs which include a control element
- be within a range of 900mm-1200mm above finished floor level where it relates to a control element, e.g. lifts and door entry systems
- be positioned, where suspended from the ceiling, to allow a minimum headroom of 2000mm



*Clear directional signage contrasting with pale wall background*

- be positioned where they can be easily touched, e.g. lift controls, door numbers, lockers and WC doors. The depth of embossing for text is a minimum of 1-1.5mm
- be sized and positioned to ensure they are noticeably visible from all angles of approach to a building.

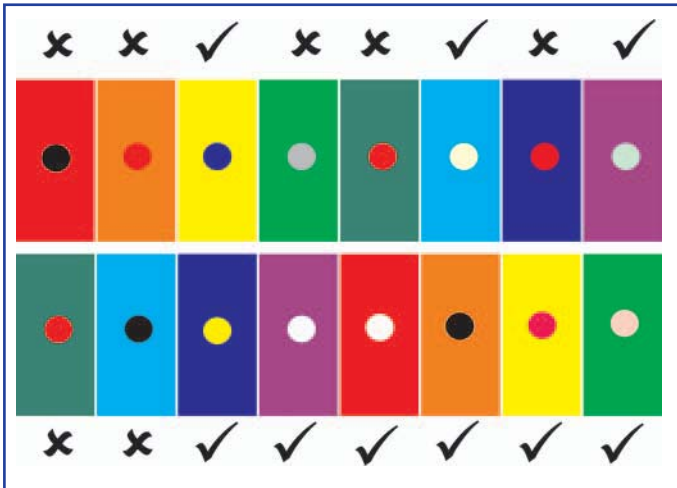

*Example of good colour contrasts*

## Colour

Colour should be in accordance with BS8300 and should be:-

- distinguishable from the background by use of suitable colour contrast
- mounted on a colour contrasting background.

## Lighting for Signs

This should accord with BS8300 and they should:-

- be provided with supplementary lighting in gloomy areas

- be back-lit, only when necessary, to levels that achieve acceptable visibility without introducing excessive glare or distortion to the colour contrast scheme.

## Specific Features

All features should be in accordance with BS8300 and should be:-

- be designed to incorporate tactile, embossed and audible elements, where possible
- be designed with Braille lettering positioned directly below standard text



*Easily identifiable signage, contrasting in colour and luminence with building fabric.*



- include pictograms, to facilitate those for whom reading is difficult.

Where there is a group of signs relating to a large department, it may be preferable to group them by colour.

*Sign with clear lettering and Braille, contrasting with dark door background*

- have a non-reflective surface and not be behind glass
- have white lettering on a dark background for good legibility if accompanied by a matt surface (for people with sight impairments, the clearest signs are black on yellow)

## Audible Signs

In buildings where members of the public are required to move around and navigate independently, audible signs should be provided. Anywhere a visual sign exists, an audible sign would be of equal value. Talking sign systems allow even totally blind people to navigate around a building and find their way to specific features such as a telephone booth. These systems work by sending recorded messages to a personal receiver, which can be heard through an earpiece or lapel badge speaker worn by the user.

In addition to wayfinding and locating facilities within buildings, the use of talking signs could be extended to wayfinding outside the building.



# Fixtures and Fittings

Fixtures and fittings should be clearly visible and access to them should be direct and unobstructed. This ensures that everyone can move around and use a building with maximum ease.

## Door Furniture

Doors considered accessible should:-

- be clearly visible and fitted with 2 permanent coloured bands that contrast with their background, fixed at 850-1000mm and 1400-1600mm from the floor. They should each be at least 150mm wide
- be held open on electromagnetic door closers where internal fire doors are required
- when automated and opening out, be designed to prevent collisions from passers-by e.g. recessed
- be fitted with furniture that contrasts in colour, e.g. a blue handle on a yellow door

- where locked, contain security features that allow independent use by people with limited reach, strength and dexterity, e.g. proximity card readers
- be fitted with door furniture that enables independent use by people who have limited grip, e.g. a lever type handle rather than a door-knob (See figure )
- not be revolving.

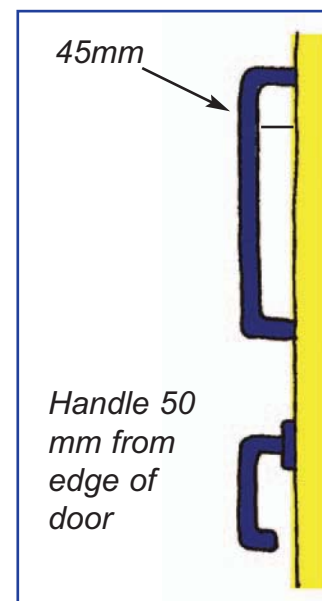

(Advice on fire doors should be sought from a Fire Officer.)



## **Lighting, Equipment, Controls and Switches**

Lighting is particularly important to aid communication and for strong definition of objects (needed by people with sensory impairments in order to safely move around).

Lighting should be:-

- at consistent levels throughout the building to reduce shadows, and areas which have patches of lightness and darkness
- sufficient for those using communicators (e.g. sign language and lip speakers)
- flexible to cater for individual requirements, e.g. those who require bright light, or conversely, to accommodate those who require a less light environment.
- flexible so that positioning can be individually controlled to avoid glare. (Care should be taken not to exceed the 2.0 glare index).

Beware: whilst fluorescent lighting eliminates shadows, it can, however, adversely affect the operation of nearby Induction Loop systems. (See section on Hearing Enhancement Systems for alternatives).

Where building users are required to control lights or equipment, careful consideration should be given to ensure that switches:-

- are automated (where appropriate), e.g. presence detecting sensors can be used to operate lights
- can be easily located and approached
- contrast in colour with the background mounting surface
- are sited at a height of 1200mm above the finished-floor level
- are easy to operate, e.g. of a large enough size not to require significant manual dexterity
- have built-in flexibility to allow for the fine adjustment of a device, e.g. air conditioning units.



## Colour

Whilst sighted people will often use colour as a subconscious sense (e.g. red for danger), people with visual impairments are reliant upon colour to give definition between objects and to create a degree of spatial and environmental awareness. By way of example, a toilet compartment with a cream door and cream fixtures and fittings, would be equivalent to a sandstorm to a sighted person. Introducing different colours to enhance key features, such as a black toilet seat, a different coloured doorframe and door handle, contrasting wall tiles etc, will transform the room into a visually accessible environment.

Dash asks you to remember that:-

- tonal contrast is important e.g. between floor and wall, handles and doors, walls and ceilings, table and chairs.
- hue and tone and how colours relate is more important than brightly coloured schemes.

- good definition can be achieved using darker colours against lighter.

Colour contrast can significantly improve access within rooms, providing:-

- door handles, finger plates and frames are in a contrasting colour to the door
- skirtings give colour contrast or tonal contrast to the wall and floor
- furniture colour is different to that of the floor
- switches and controls significantly differ in colour from their background.

# Eating and Drinking Areas

For many people, eating out forms part of their social, domestic or business life. It can also be essential for people who need to eat regularly. Naturally, every business offering a catering and hospitality service will want to do everything possible to ensure that all customers are welcome and able to enjoy comfortable surroundings. To ensure that all customers receive the same level of service, restaurants, bars and public houses are required to offer barrier-free environments, as well as make adjustments to the way in which their services are delivered.



*Easy to reach, wheelchair accessible servery*

## Layout

Certain types of establishment are more suitable for particular events, activities or clientele and their layout and facilities will vary widely. However, layout, facilities, and services should be designed in line with BS 8300 and should include:-

- generic menus which are in a large clear print, to allow people with visual impairments to make independent choice



*A choice of seating height with and without armrests*

- signage that welcomes people with Service Dogs, e.g. Enabling, Guide, or Hearing Dogs, etc.
- access to all facilities and services from all areas, with passing and manoeuvring space, as appropriate
- table seating that is not fixed to the floor, to allow wheelchair users access to the table
- provision of tables, which allow wheelchair users to comfortably reach their food, etc.

- self-service shelves between 800mm and 850mm, and any dispensing units required at a higher level, no greater than 850mm to 1000mm high, i.e. to enable easy reach of cutlery, plates and trays, etc



- a mix of round and square shaped tables with rounded edges
- service counters at a height between 750mm and 850mm from the finished floor, with knee recesses as necessary
- seating which accommodates a range of needs (i.e. chairs with and without arms and seating which is high and low)
- readily available and conveniently reached WC facilities.

## Café Culture

To maximise pedestrian access and minimise the potential dangers which tables and chairs can bring to those with impaired vision or mobility, the Council licences areas of the highway where outdoor seating is permitted under Section 115E of the Highways Act 1980. To have an application for outside tables and chairs businesses must demonstrate:

- an ability to store all outdoor furniture within their premises after close of business to allow thorough street cleansing
- the ability to mark out the appropriate enclosure using features such as planters and/or fencing which can act as a tapping rail for white cane users, without compromising the aesthetics of the environment
- provision to ensure that all features used within the licensed area (with the exception of chairs) are fitted with fixing mechanisms to ensure they are secure and positioned in the same place each day

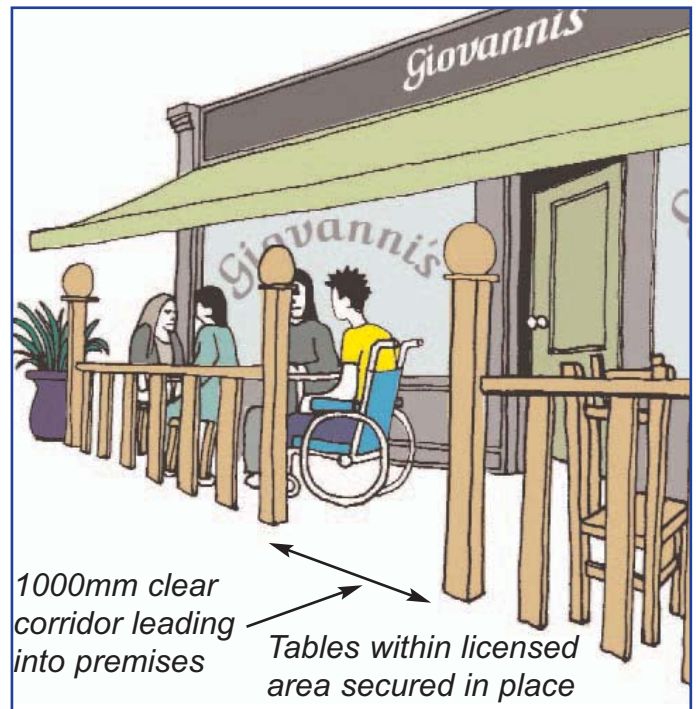

- a clear corridor between tables and chairs of 1000mm leading to the entrance door, to ensure unobstructed access into the premises for all customers
- an entrance door with a clear opening width of 830mm
- that seating can be provided whilst maintaining a minimum of 1.8m of adjacent pavement width
- that any litter bins provided, do not impede access.

# Leisure and Entertainment

Harrow Council recognises that to create communities that are active and healthy, there needs to be a range of activities that allow people to relax, interact socially and enjoy organised recreation, or have contact with nature. Therefore Harrow Council will be paying particular attention to accessibility in relation to leisure and entertainment planning applications.

Recreational/entertainment facilities should:-

- be available for everyone who wishes to take part in any activity, to the extent they wish
- be readily available to disabled people without needing to provide advanced notice
- allow seamless social interaction by people not necessarily taking part.

## Parks and Open Spaces

Whilst it is important to maintain as much of the natural environment and

rugged aesthetics as possible, sometimes compromises need to be made to ensure that everyone is able to enjoy the views and all features of interest.

Each individual site and its features will need specific access considerations. Key access design principles could include:-

- hard surfaced and well defined tracks
- pathway surfaces that are stable and level whilst keeping any camber to a minimum
- paths 1.2m wide and non-slip, well lit and clearly defined using texture and visual contrasts
- vehicle access and on-site parking
- pedestrian entrances which permit easy movement for people with mobility impairments and which are physically separated from vehicles gaining access



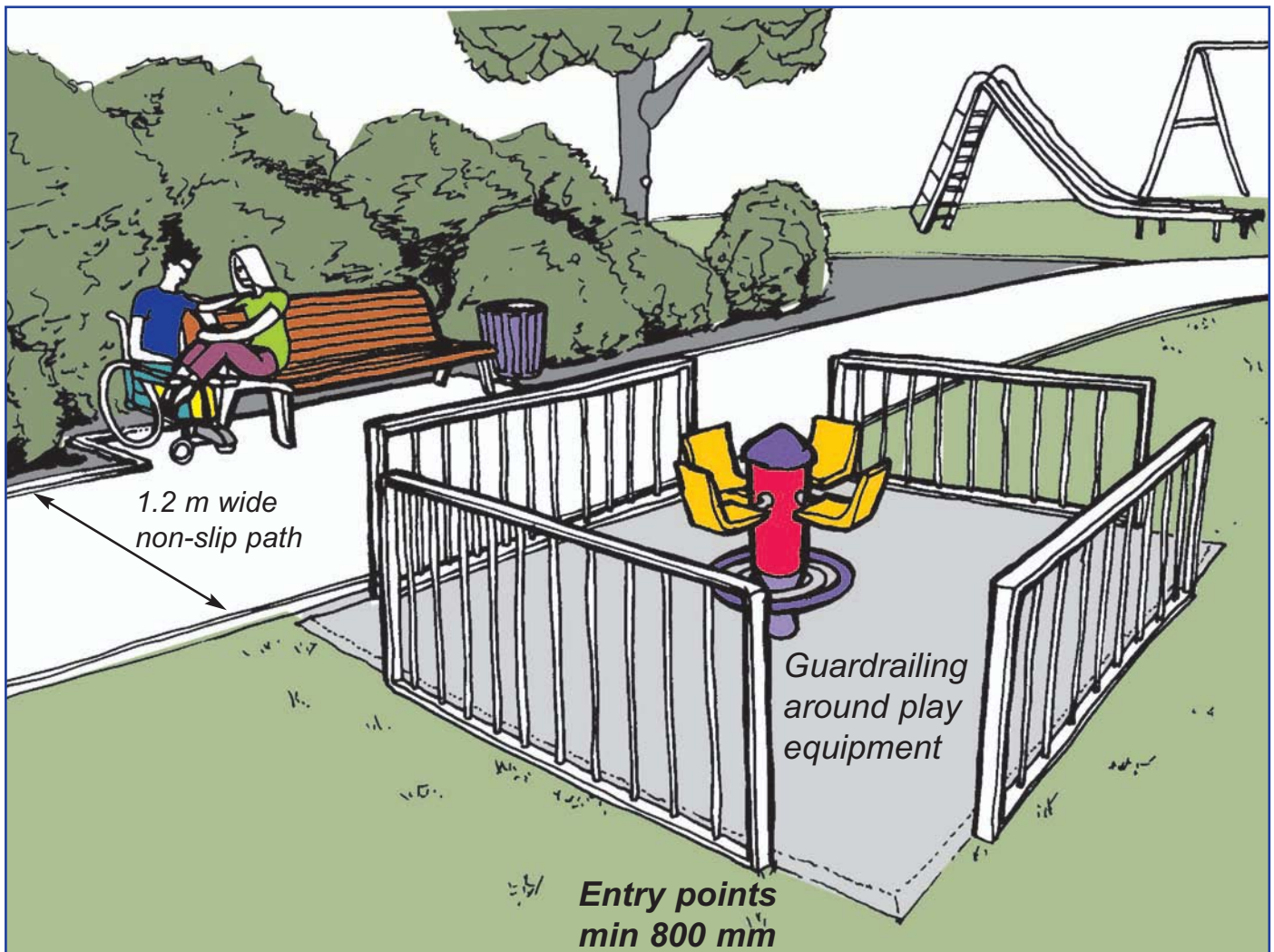

- an indoor information centre or adequately sheltered information points
- fully accessible toilet facilities designed to BS 8300 (where provided)
- tactile and audible information boards
- landscape and vegetation carefully designed, positioned, and maintained to avoid injury to passing pedestrians (a thorny rose bush may not be easily detected by a blind person)



- appropriately designed accessible signage
- suitable playground area surfacing for easy wheelchair manoeuvrability
- shelter from (unexpected rainfall) that is of sufficient depth to allow use by those with mobility equipment, e.g. pushchairs, wheelchairs, and similar
- shelters that assist in reducing reflection glare when reading information boards in bright sunlight
- seating and resting facilities that are at intervals of approximately every 200m and which are inset from the path
- mobility aid access to viewing areas and features of interest, e.g. hides, viewing platforms and equipment
- seating areas incorporating an adjoining space for a wheelchair or pushchair to be positioned alongside the provided seating
- access to features of specific interest.

## **Playgrounds and Children's Play Areas**

Whilst playgrounds and children's play areas may require additional security and safety provisions, they should nonetheless be designed to standards which allow use by children with disabilities, or by a wheelchair-using parent, supervising a child.

Similarly, play facilities should promote integration between disabled and non-disabled children by offering a variety of play opportunities using different materials and textures to provide a range of options for all children. Facilities should also be designed to allow parents with impairments to assist their children to enjoy the facilities.

There should be:-

- security or restricted access features that allow full use by those with mobility and sensory impairments
- some soft play surfaces, however as much of the natural environment as possible must be maintained

- separate areas for restful and energetic activities
- places for supervising adults to watch, sit or take part in activities
- a layout in all areas that is obstacle free and can allow a wheelchair and a pushchair to pass each other at the same time
- features allowing visually impaired children to obtain an equal degree of enjoyment
- provisions to allow all parents to interact with their children.
- appropriate guarding for swings, slides and merry-go-rounds to avoid potential injury to people with visual impairments
- features that allow easy, safe, flexible and convenient use by wheelchair-using adults assisting children



*Accessible Childrens Playscheme*

## Keep Fit Areas and Gyms

Many people, including wheelchairs users, can enjoy training and bodybuilding activities providing the equipment is carefully selected. Equipment must be easy to use and wherever possible be accessible from a wheelchair (without major adjustment) and safely operated by people with visual impairment.

Equipment provided should include at least one:-

- upper body multi-station, accessible to wheelchair users
- upper body ergometer, accessible to wheelchair users
- treadmill
- recumbent bike, accessible to wheelchair users
- leg-raise with cams
- leg-curl with cams.



Equipment should be:-

- laid out with adequate space for the fitness activity and for safe circulation between pieces of equipment.
- on the same level as the circulation areas unless there is suitable ramp provision.

Further information relating to access to other sports facilities, including sports halls, synthetic and hardsurface tennis courts etc, can be obtained from the Design Guidance Note “Access for Disabled People”, published by Sport England [www.sportengland.org.uk](http://www.sportengland.org.uk).



*Paralympian, David Weir, demonstrates accessible fitness equipment at a Sport England training facility*

## Swimming Pools and Leisure Pools

Swimming is a social activity and has many proven health related benefits including stress reduction, calorie burning, alleviating pregnancy discomforts and gaining a sense of euphoric well-being. Buoyancy and the resistance properties of water provide an added benefit to people who need exercise without strain to joints, muscles and breathing.

Facilities should therefore conform to the requirements of BS 8300 and should include:

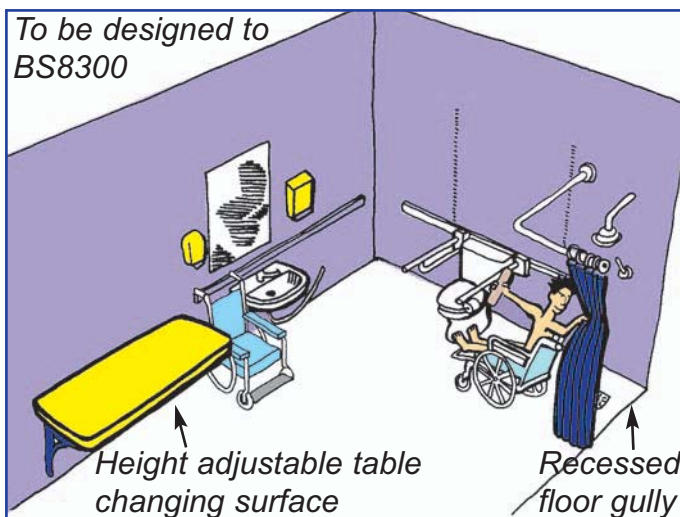

Accessible Changing and Shower Room

- a route from the changing areas to the pool(s) which is continuous, unobstructed and slip resistant
- a privacy cubicle that is also accessible to disabled people either to use independently or with another person assisting
- pools which have a minimum of 2 accessible means of entry
- a means of pool entry which is provided either by access or provision of a pool lift designed to be operated by the user
- leisure pools where everyone gets in and out of the same areas and which are accessible to all, ie: zero grade beach entrance
- an aquatic wheelchair designed for use in the water where there is sloped access
- swimming pool ramps designed in accordance with the guidance given in Part M to the Building Regulations 2004

- transfer walls of suitable width and height provided as an intermediate surface and with a convenient recess to leave a wheelchair
- access to all facilities including locker and dressing rooms.
- grab bars which are perpendicular to the pool walls extending the width of the wall
- a top gripping surface of 10-15cm above the wall to allow for leverage and at sufficient height to allow clearance

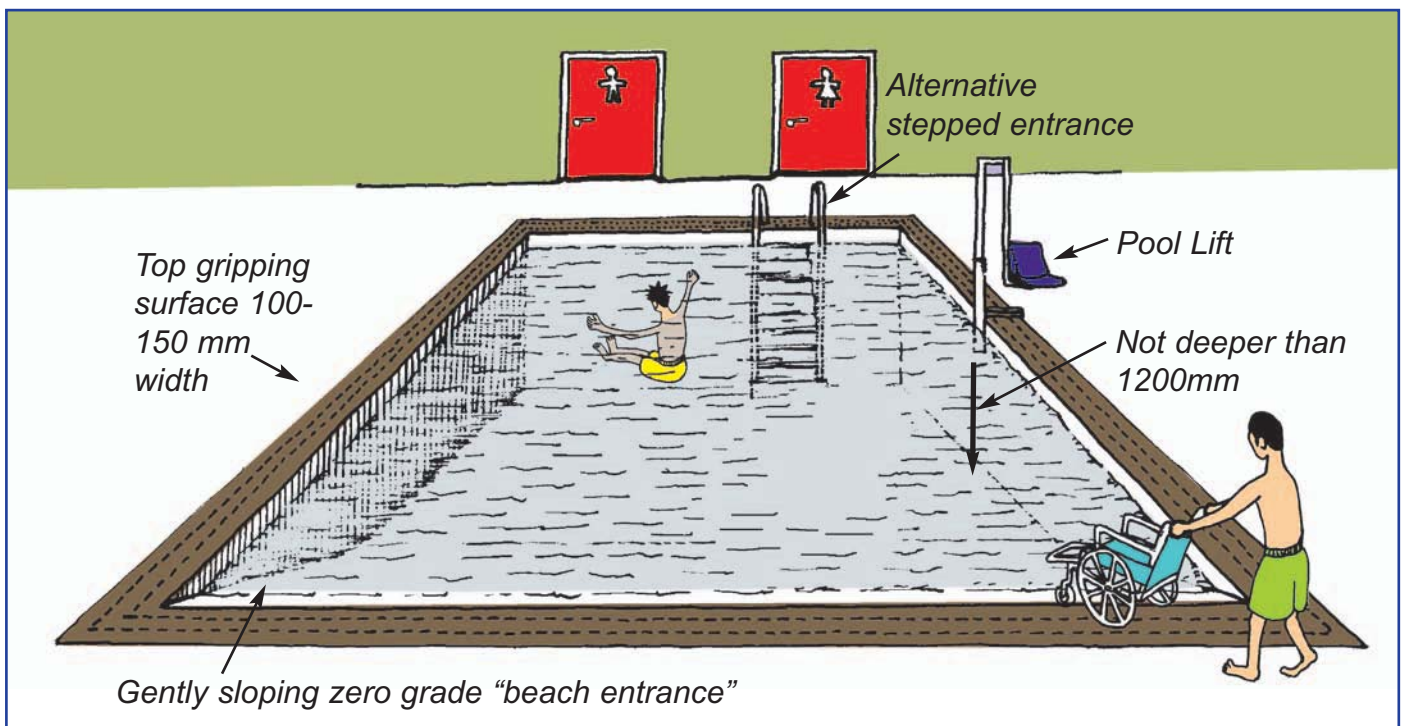



## Pool lifts

Pool lifts should be: -

- not deeper than 1200mm at the deepest point as this allows someone providing assistance to stand up in the water
  - provided and positioned to give clear deck space to allow its user to easily transfer to the lift seat whilst also providing sufficient space for those assisting
  - provided with backrests and seating in a suitable material which reduces slipping
  - capable of supporting at least 135 kgs.
  - operable by one hand and should not require dextrous hand movements or excessive strength
- designed and placed for use without assistance, with dual controls for operation both within or outside the pool
  - designed so that the seat submerges to a minimum of 450mm below a still water level to help ensure buoyancy



*Pool-lift to facilitate safe and easy swimming pool access*



## Spectator Seating & Viewing

Spectator seating for structured recreation (e.g. sports stadiums, cinemas and theatres) should provide people with physical and sensory impairments with a choice of position, integrated amongst the audience to prevent family or friends from being separated.

To be accessible, spectator seating should conform to BS 8300 and should:

- be flexible so that the area can be used by a non-transferring wheelchair user if necessary
- provide wheelchair users with clear, comfortable sight lines without visually obstructing the view of others
- provide one wheelchair space in every 50 provided seats and some areas where 2 wheelchair users can sit side by side
- incorporate seating of varying dimensions to accommodate a range of comfort and access needs
- allow people who experience seizures to use an area of spacious seating that is integrally designed into the general layout.
- be positioned to enable easy viewing of performances whilst allowing easy viewing of transcription, e.g. sign language interpreters
- include provisions for people with sensory impairments to enjoy spectator activities, e.g. assisted hearing/listening devices, audio and visual transcription
- be non-fixed, where appropriate, to increase choice and flexibility

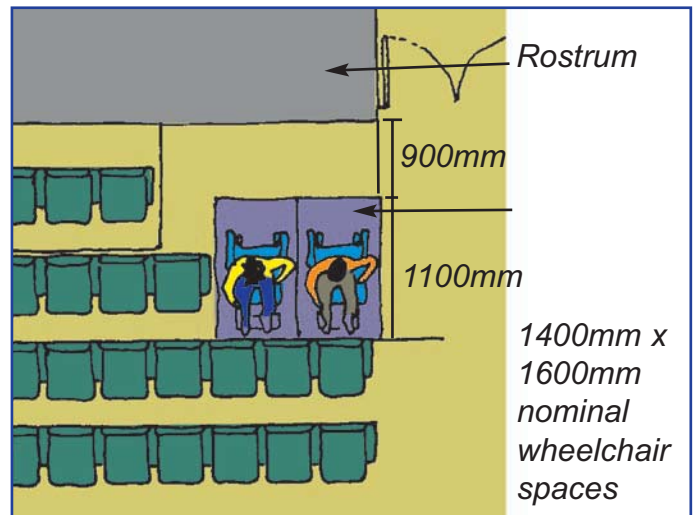

- provide some wheelchair positions which are close to the doors to allow exit and entrance during performances without disturbance
- include seating areas that can also accommodate wheelchairs when allocated spaces are taken

As some impairments are sensitive to flashing or flickering light, performances where this is likely to occur should provide audiences with prior warning.

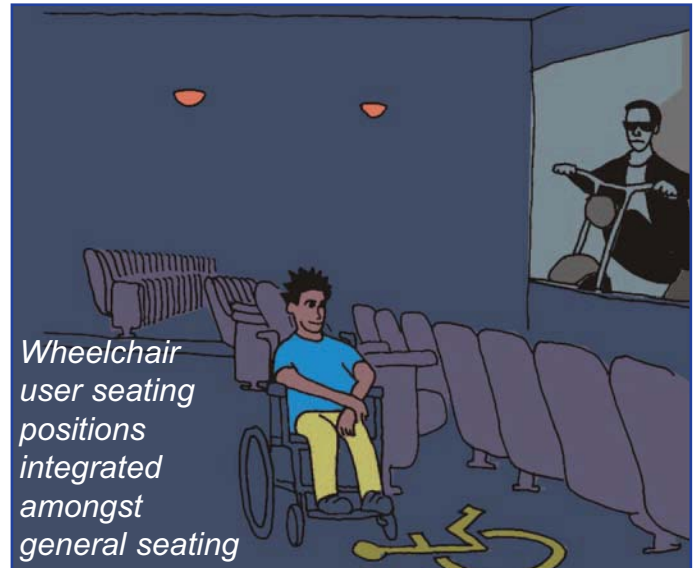

## Community Centres

Community centres such as dance halls, youth centres and scout huts are often a valuable resource to the local community. Their very nature attracts a diverse range of people and uses, and access for all must be thoroughly considered. In addition to the primary access considerations, provision should also be made available to:-

- raised speaking platforms and stage performance areas
- food preparation and serving areas
- changing and back stage environments
- public address systems which are interfaced to a Hearing Enhancement System.

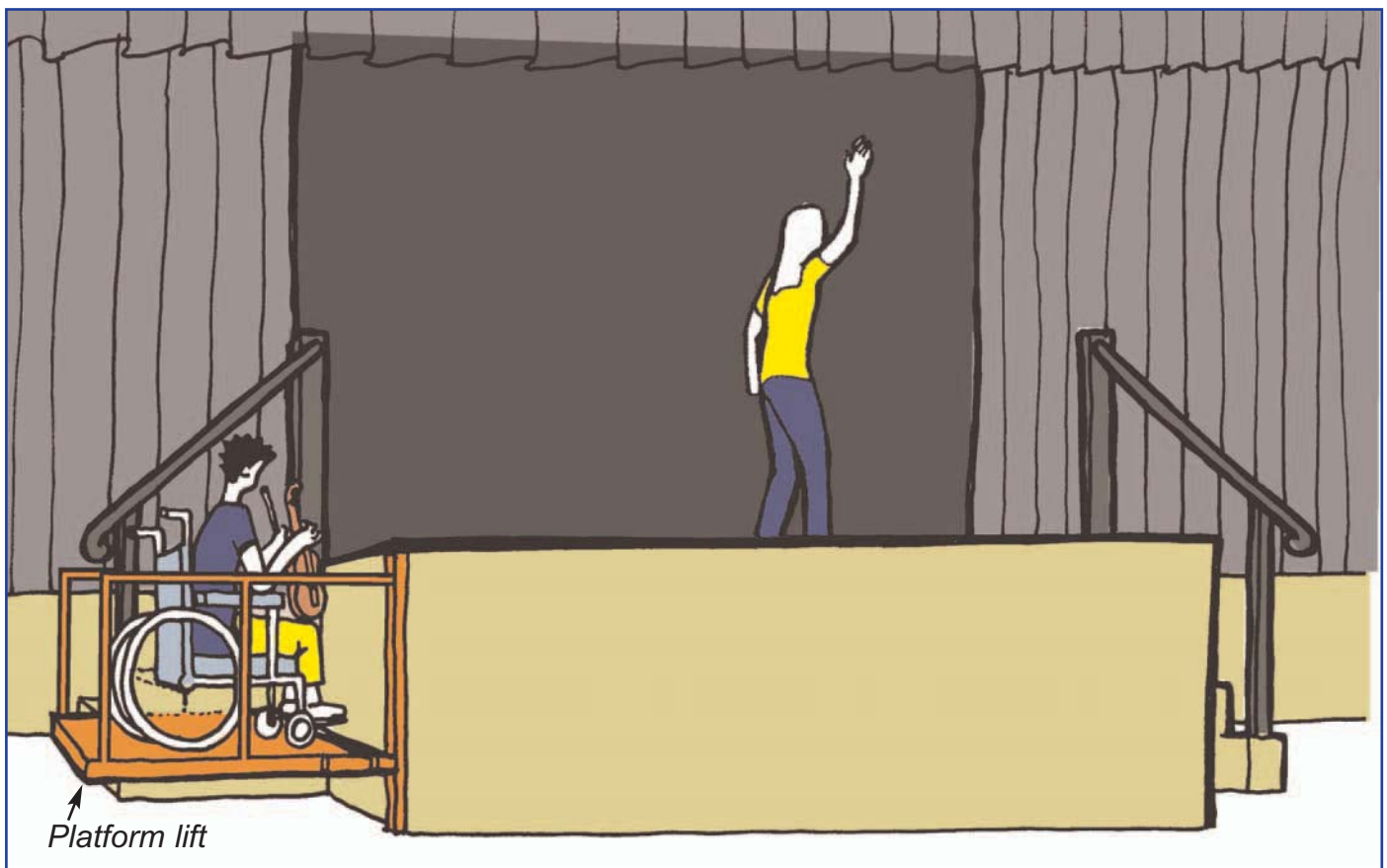

## Places of Worship

Whilst remaining sensitive to cultural differences and religious values, access needs to be seamlessly integrated without compromise to either individual access needs or religious beliefs and practices.

Religious establishments should conform to BS 8300 and should:-

- keep some seats near the entrance reserved for people who cannot stand for extended periods or for those who may need to leave early
- provide seating of the non-fixed type
- have some seating available in areas where it is not normally provided
- provide cleansing for wheelchair wheels, where required
- provide waiting areas for assistance dogs to wait in comfort just outside the worship area if necessary
- allow participation at all levels ensuring all areas and facilities including altars, aisles, choir galleries, organ loft and bell ringing towers are accessible
- where it is possible, have ambient temperature maintained at a comfortable level of 65°F
- provide assisted hearing systems (see section on Hearing Enhancement Systems).



# Buildings of Special Architectural or Historic interest

Everyone should be given an equal opportunity to enjoy, learn about and have access to their heritage. Creating access for wheelchair users into buildings of special interest often requires a greater degree of ingenuity and creative thinking to achieve an access solution that does not compromise the original beauty of the building. When creating access into existing buildings there is always a

degree of compromise to be made and special permission, e.g. listed building consent is likely to be needed. (Early consultation with the Conservation Section of the Planning Department is therefore advisable.) It has been proven time and again that with a dedicated approach and financial commitment, it is possible to unobtrusively achieve good access design for a special interest building.

Considerations for buildings of special interest should incorporate the requirements of BS 8300 and could include:-

- curved ramps or surface re-grading
- garden paths of hard paving or slabs for easy access to all parts of the grounds
- careful modification of significant features to incorporate access equipment which is hidden when not in use

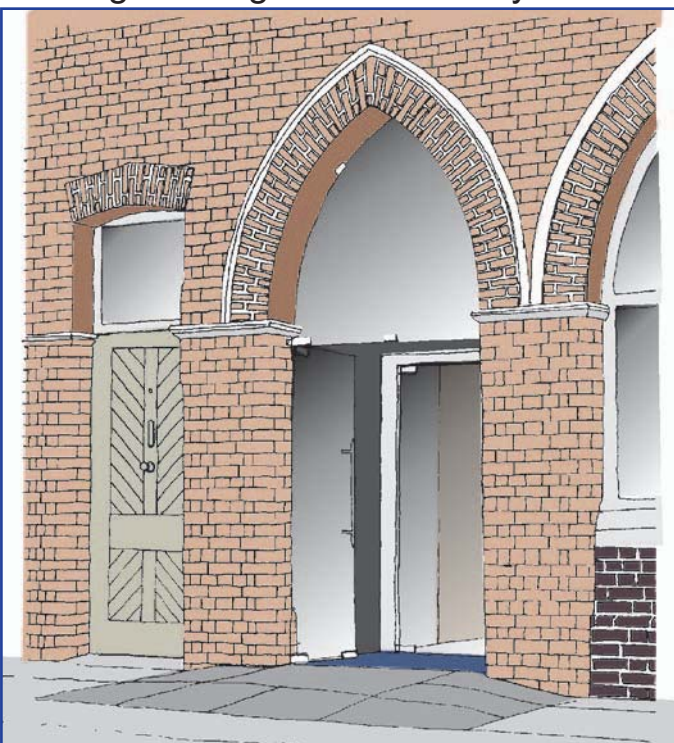



- the use of high quality materials, sympathetic to the character of the building
- solutions that incorporate significant features, taking their cue from the architectural character of the existing building
- use of modern day technology (as a last resort) to transmit and present views of areas where creating access would destroy the aesthetics and character of an existing feature, e.g. narrow stair to views above
- careful use of colour contrasting and lighting to improve visibility for those with visual impairment
- door handles, not knobs for easier use by those with restricted hand strength or dexterity
- accessible toilet facilities
- hard surface flooring and low pile carpets internally
- physically accessible information, books and other written material, available in various formats.

Funding may be available to help with access alterations, e.g. Heritage Lottery Fund. Contact the Council's Conservation Section for further information.



*St Anselms Church before access improvement work*



*St Anselms Church after access improvement work*



*New accessible features remain in keeping with existing church*



# Education and Learning Establishments

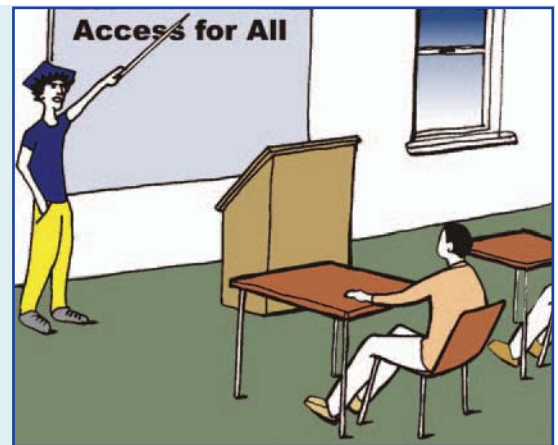

Learning is a fundamental part of everyone's life from nursery onwards, and access for all is a must. Students with mobility and sensory impairments have been legally empowered to learn in an environment that is barrier free and where discriminatory practices have been eliminated.

Education and learning establishments should follow guidance laid out in BS 8300 and should ensure that:-

- a building is designed to encourage social interaction of all, including areas such as, refreshments, and quiet study places and recreational opportunities
- buildings and facilities promote barrier-free circulation, using features such as open plan reception areas, automatic doors, etc
- equal access is provided to all public areas, social areas and learning activities, in order to allow students to participate inclusively
- all learning areas include desks or work benches that are flexible or adjustable in height
- teaching areas have built-in flexibility which supports the integration of students with diverse needs, e.g. height adjustable cooking and washing up facilities, one handed computer keyboards, and equipment such as fans and heaters to assist students whose impairments are affected by changing temperatures
- all students are able to gain entry to all buildings through common entrances

- study areas include soundproof places e.g. in the library, to allow people with visual impairment to be read to
- living accommodation is accessible for visits by students with disabilities and that a proportion of rooms are readily adaptable to suit individual needs.

## Libraries



Libraries should be designed and equipped to allow all users to gain equal access to the entire range of services and should include:-

- suitably designed reception and check-out desks (see section on Reception Areas)

- automated security barriers at entry and exit points that allow sufficient space (a clear opening width of at least 1200mm) for wheelchair users, guide dog owners and parents with young children to gain easy and independent access
- reading materials in alternative formats to allow independent learning by people with visual impairments, e.g. talking and large print books, close circuit screen readers, magnifying equipment, user controlled supplementary lighting, etc
- reading materials in other languages, also in accessible formats

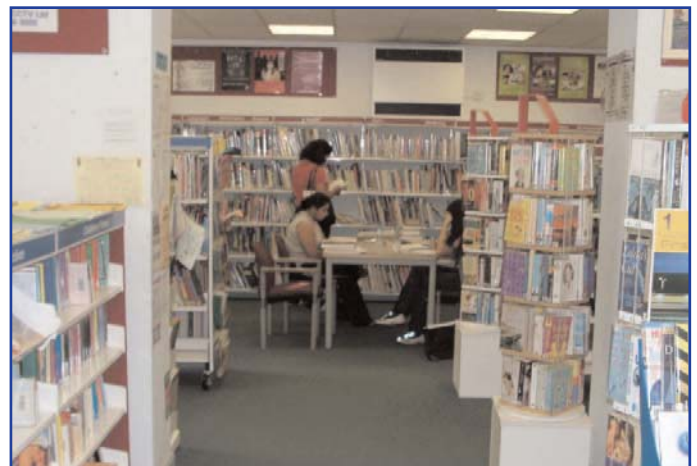



*Lower shelving to minimise stretching*

- shelving that has been carefully selected to ensure the design facilitates maximum independence e.g. book cases with shelving of equal depth, colour contrasting to define bookcase edging
- floor colour or tonal contrasts which distinguish reading areas from circulation routes
- a uniform approach to library layout in premises with more than one library, e.g. a university.



*Easily identifiable accessible parking and access route to library*

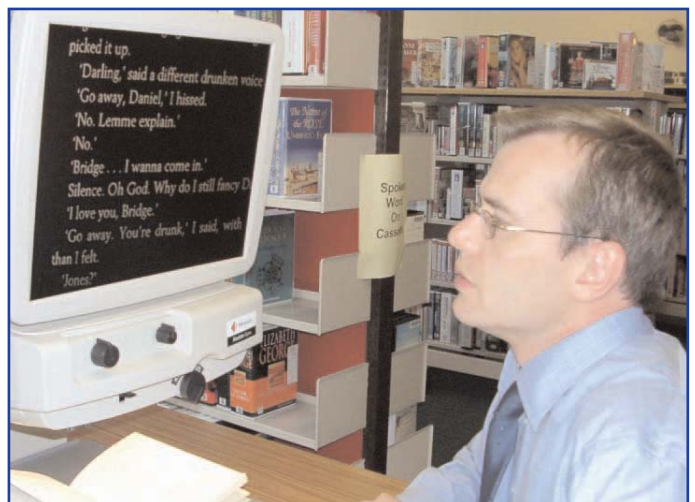

*Text enlarger to magnify small writing*



# Overnight Accommodation

Thought needs to be given to all aspects of every customer's needs, from entry to full access to all facilities, (including grounds) thereby providing the same amount of customer service to all. Simple modifications and a little thoughtfulness can generally provide any necessary solutions to allow personal independence for a disabled person. As disabled people are often reliant on attention to detail, small things can help make a disabled person's stay a manageable and pleasurable experience. Accommodation establishments should follow guidance laid out in BS 8300 and should include:-

- accessible parking
- reception areas accessible to all customers
- fully accessible toilet facilities
- access to all public facilities, e.g. restaurant, bar, beauty salon, library, leisure/games room, lounge, reception, etc



*Accessible route from car park, using carefully selected 'wheelchair friendly' paving*

## Bedrooms

Provision should be made for:-

- all bedrooms to have a minimum door width of 750mm and space to manoeuvre a wheelchair within the room
- door locks and handles that are easy to operate by people with reduced grip or dexterity



*Wheelchair accessible bedroom*

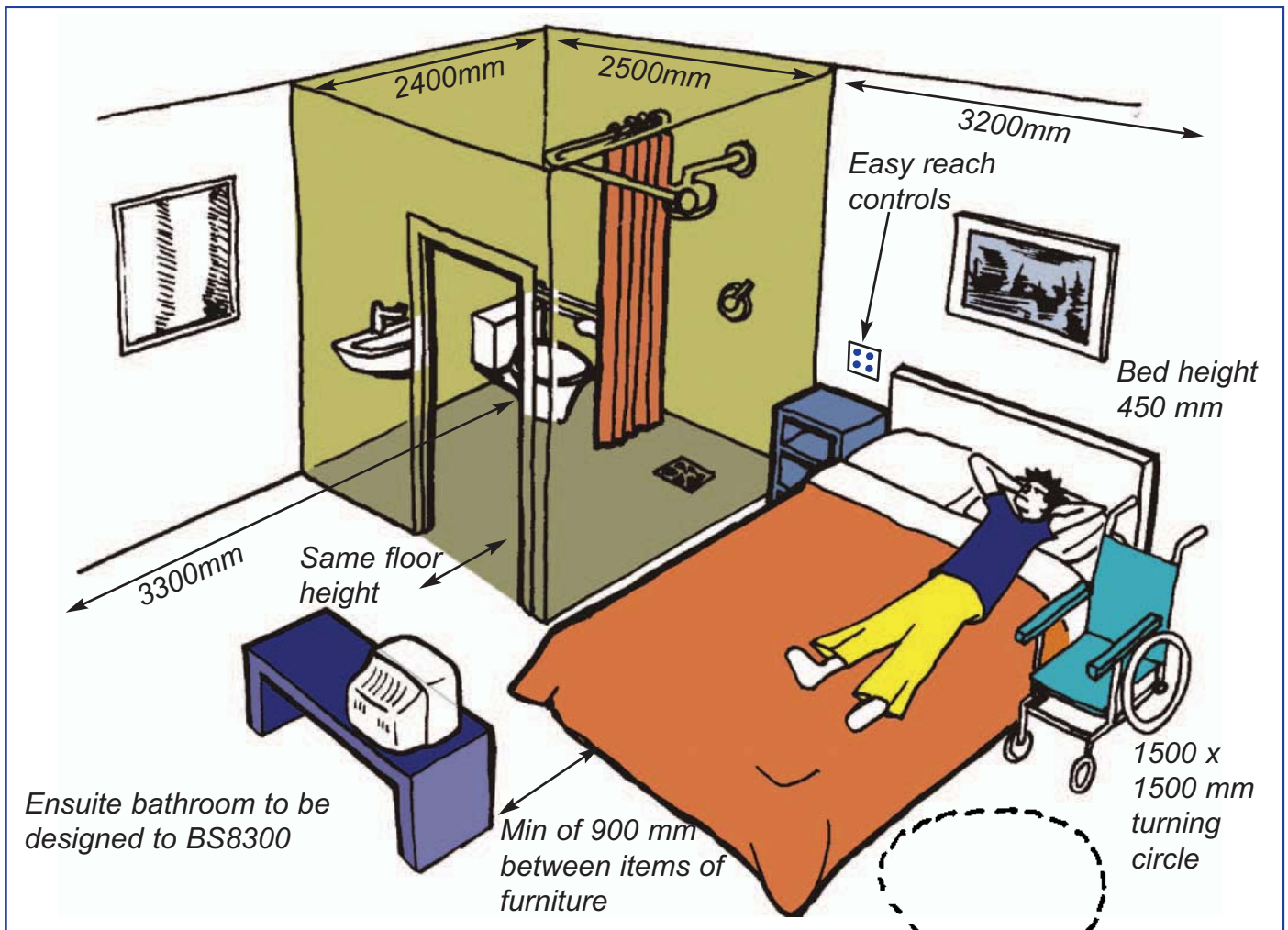

- a minimum quota of 1 in 20 bedrooms fully equipped for use by wheelchair users, with at least one twin, double, single, or family room per establishment
- wardrobes and drawers at an easily reachable level
- level entry to an en-suite bathroom
- a bed that is firm enough to give support during transfer and at a height to allow it (450mm)
- desks and tables that give room for footrests and knees

- level access to any balcony or terrace
- reachable and easily operated lighting and temperature, TV, radio and curtain closing controls
- a room telephone operable by anyone with a hearing impairment
- a TV capable of receiving subtitles or for use with a listening device
- access to room service, e.g. ironing, washing, refreshments
- flooring that allows a wheelchair user to move about, e.g. low pile carpet
- at least two mains electrical sockets in close proximity to the bed to allow use of equipment such as wheelchair battery charger, portable hoist, ventilator or communication device.
- shower facilities that can be used by people with portable shower chairs
- lever tap controls
- sufficient space for inward opening doors to close behind a wheelchair (thought could be given to sliding or outward opening doors instead)
- a layout that allows for lateral transfer to the WC or bath
- adjustable height washbasin, positioned to allow a wheelchair to approach and be close

## Bathrooms

Facilities within fully accessible rooms should be designed to meet BS 8300 and should include:-

- rail supports

- full length mirrors to suit different height users
- provision for rails and a platform at the head of the bath to facilitate movement in and out of the bath.



*Accessible ensuite bathroom with 'wet floor' shower facility*



# Emergency Provisions & Means of Escape

Designers, developers and building operators are required to seamlessly integrate accessibility into a single, effective, and manageable building emergency plan to ensure that people unable to use stairs can be confident of escape, even during an intense emergency situation.

## Providing Accessible Alert & Escape

Providing a safe means of escape for people with mobility or sensory impairments will vary according to the type of building and the purpose for which it is used.

Emergency provisions should be in line with BS 5588 and should include:-

- reliable and flexible systems, e.g. a vibrating and message paging system
- escape routes that allow everyone to follow the same escape route to reach a Refuge area.

## Refuge Areas

Refuges are fire-protected areas where anyone unable to escape from a building using the stairs, can wait in safety, ie: away from smoke. In buildings of two or more storeys, the Council may require provision of at least one suitably designed refuge. Refuges should:-

- be designed to BS 5588
- be at opposite ends of the building, with two provided on each floor when the distance to the refuge exceeds 50 metres
- be large enough to take one or more wheelchair users(s), whilst allowing those using stairs to easily pass
- contain at least one evacuation chair
- contain a fire protected lift (designed to BS 5588) that can be used during a fire



- have clear signage that indicates their exact location
- display notices that provide clear and reassuring instructions to explain the purpose of the area, the relevant emergency procedures and protocol
- be fitted with 2-way communication devices that are suitable for those with hearing, visual and speech impairments, eg a series of pre recorded requests of assistance messaging.

### **Evacuation by Stairs**

Evacuation chairs and similar manual methods of evacuating disabled people should be used as a last resort.

## **Procedures and Training**

To meet the needs of people unable to use stairs, good building management requires that Generic Emergency Evacuation Plans be devised. For those using a building on a regular basis, e.g. staff members, personal emergency evacuation plans (PEEP's) need to be tailored to an individual person. They should also include, elderly people, expectant mothers, parents with young children, and disabled people. Whilst these plans should follow the BS 5588-8:1999 guidelines, they should also include procedures that ensure:-

- a means for recording who is in the building, whilst noting any specific emergency egress requirements.
- a nominated person(s) with overall responsibility for evacuation exists
- building management and front-line staff receive regular refresher sessions of all emergency arrangements
- building users are familiar with evacuation procedures

- wardens and those responsible for evacuation receive training in disability awareness and in providing assistance to people with mobility or sensory impairments.
- personnel with responsibility for assisting during an evacuation are fully trained should the need arise for manual methods of evacuation

## **Evacuation Responsibility**

It must be remembered that the responsibility for building evacuation ultimately rests with the operational management of the building. The Fire Brigade will not accept responsibility for routine escape arrangements and will expect to arrive at a building that has been evacuated.

# Communicating & Accessing Services

Ensuring high standards of physical access into a building is the first step to promoting 'Access for All.' However, delivery of quality services is just as important.

Some people have impairments that are obvious, e.g. those using a wheelchair. However, providing access extends beyond the requirements of wheelchair users and should include (for example) considering the needs of people with:-

- epilepsy
- visual impairment
- impairments affecting balance and/or co-ordination
- heart conditions
- speech impairment
- learning disabilities
- hearing impairment
- restricted breathing.



Disability awareness training is an effective way of achieving increased knowledge of peoples' differing needs and should be incorporated into general customer care training or specific Continued Professional Development.

## Talking with Customers

Every customer is different and has their own individual communication requirements. Providers of services should actively demonstrate helpfulness and courtesy.

Sometimes people who are unfamiliar with disability find it difficult when speaking with a disabled person and may become embarrassed, perhaps pretending that they have not seen or heard them. Others may stare through curiosity or fear, forgetting their customer service role, whilst making assumptions about a disabled person's communication or intellectual ability. There is often uncertainty around offering help to disabled people as there is concern that it may offend. It is perfectly reasonable to offer a disabled person assistance, particularly if you feel there is a degree of struggle. However, you should never assume that your help will be needed and you should always be prepared for your offer to be declined. Despite every good intention, never give help without seeking permission first, as this is likely to offend.

The best way of reacting is to remember to treat all customers equally, using terminology that will create the right atmosphere of acceptance. It is important not to make disabled people feel they are being treated differently or 'spoken down to'.

## **Tips for Communicating**

When communicating with customers it is important to;

- make eye contact
- shake hands
- smile and be welcoming
- stand or sit facing the customer
- smile with your voice
- speak clearly with an even rhythm of speech
- face your customers to allow for lip reading
- use gestures which complement the conversation
- re-phrase what you have said if you have not been understood
- be patient, particularly where there is difficulty in explaining - check for understanding

- use everyday humour and avoid stale clichés, e.g. 'Have you got a licence for that wheelchair?'
- write things down if it will help clarify
- speak directly to the customer and not through their companion, spouse, assistant, or interpreter, e.g. 'Would she like some sugar?'
- speak to adults in an adult manner
- use language that is positive. Avoid collective nouns e.g. "the disabled" or language which is negative (e.g. "the mentally handicapped"), better phrases are 'disabled people' and 'people with learning disabilities'
- respect individual personal space, e.g. a wheelchair is an extension of its user and should not be leant upon without permission
- respect that guide and other assistance dogs are not pets, whilst they are working, and should not be distracted from duty
- be relaxed and take time to listen
- ensure that people who are affected by seizures are made welcome and ensure knowledge of what help can be offered during and after a seizure
- use normal language - a speech impairment or stammer does not infer low intelligence
- sit or crouch down when talking to a wheelchair user, to ensure level eye contact.



## **Product or Service Information**

When producing written material for customers, a single, accessible product that can be easily understood by all, is the most viable and cost effective option and ensures that service providers adhere to the most recent DDA legislation.

Written information should be:-

- clear and concise
- complemented by symbols, wherever possible
- available electronically
- produced in one format, suitable for use by everyone
- a minimum of point 12 sized font on a contrasting background.

## **Ways of Communicating**

Customers who need assistance with communication, should be offered the opportunity to communicate with the same degree of spontaneity as non-disabled people.

Some of the ways in which assistance may be offered are:-

### **Video Linked Lip Speaking and Signing**

These 'dial-in' services are available to subscribing organisations, for situations where talking to customers face to face, (e.g. interviews or meetings) is required. The equipment should be positioned to allow all involved to maintain both a natural seating position and confidentiality.

### **Hearing Enhancement Systems**

Assisted hearing devices such as induction loops or infra-red systems, can help in eliminating background noise, enabling hearing aid users to link directly with the sound source, e.g. a film at the cinema or the microphone of a speaker.

## Text Phone & Typetalk Services

Organisations should consider purchasing a text phone device for people with speech or hearing impairments. This allows customers to make contact, still using the telephone, but typing their conversation instead of speaking.

For smaller organisations a subscription to the RNID Typetalk service should be considered. Using this service, only the person with the communication impairment is required to have a text phone. The Typetalk operator will read to the hearing person what has been typed. The hearing person will then reply

by speaking to the operator, who will relay the conversation back to the person with the hearing impairment by using a text phone keyboard.

## Public Telephones

If a public telephone is provided in the building, it should be positioned in accordance with guidance in BS 8300.



## Cashpoint Machines

As new technologies continue to emerge, providers who install and maintain these facilities should ensure that they are suitable and accessible to everyone.

Cashpoints should be designed in accordance with BS 8300 and should:-

- have an area immediately in front of the machine which is level, clear of obstacles and well illuminated
- be easily reachable by means of a door security system which does not require fine manual dexterity, particularly if located in an internal lobby at night
- have screen illumination that is adjusted automatically according to surrounding light conditions
- incorporate technology which allows users to hear verbal instructions through headphones
- have controls and card slots at a height of 1200mm.

- have at least one cashpoint machine per facility, at a height suitable for wheelchair users
- incorporate technology which allows for people with sight impairments to hear on-screen instructions confidentially through an earpiece device.

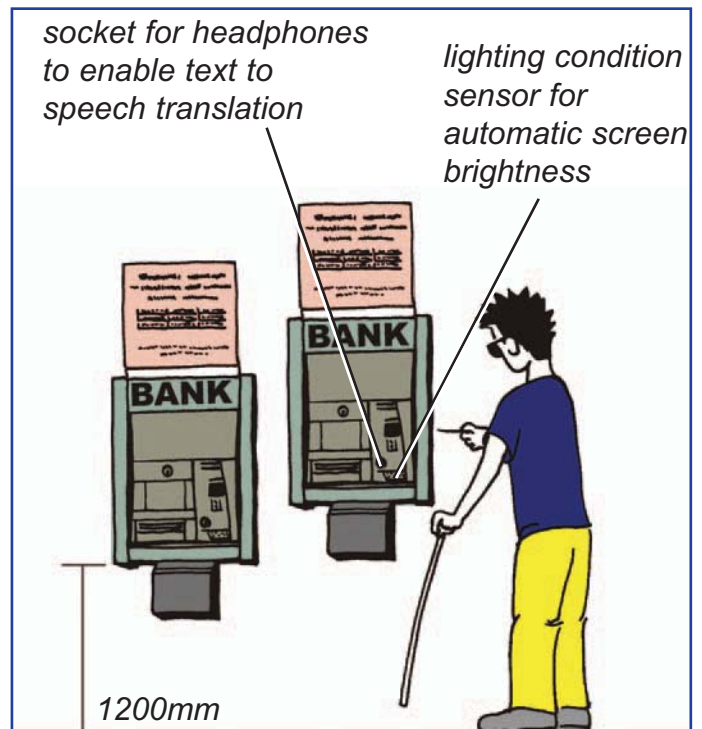

## Electronic Information Points

Electronic Information Points, such as those available in the high street,

shopping centres, and other public arena, should be fully accessible to all disabled people.

To ensure accessibility, information points should:-

- display text and graphics on a starkly contrasting background
- provide physical access, allowing wheelchair users to approach and easily reach keyboards, touch screens and payment slots, from both front facing and side approach angles
- provide low level computer terminals (between 750mm -800mm high)
- provide seating, which is adjustable in height by the user.

### **Accessible Information**

Producing information electronically ensures that information can be tailor-made to suit the favoured format of the reader, thereby promoting equality and increased independence for many people. Examples of how electronic information can be used are:-

- Text to voice readers - these read aloud what is written on a computer screen
- Text manipulation - this can be used to alter the size of text
- Screen magnification - this can enlarge text, diagrams, pictures, graphs, etc
- Print - with specifically chosen colour-contrasts, or braille embossing

### **Accessing the Internet**

Technology now exists, which can assist visually impaired, and blind people to use the Internet. Where a computer or Internet service is provided, at least one, or one in every twenty, terminals should be fully accessible and incorporate:-

- height adjustable desk and seating
- synthesised text-to-speech screen readers
- braille printing
- screen magnification
- colour printing.

## Accessible Websites

Accessible websites are not only quicker to access, but also help service providers towards achieving their “duty to eliminate discrimination”. Websites should be designed in line with the Web Content Accessibility Guidelines, produced by the World Wide Web Consortium. The guidelines explain how to design and produce a single website that promotes ease of use by everyone, without the need for a separate text-only alternative.

- use of British Sign Language, as appropriate
- providing information in pictorial and in clear, easy to read formats

Further information can be obtained by visiting [www.w3.org/WAI](http://www.w3.org/WAI)

Methods for providing accessible websites include:-

- Providing a text to speaking voice feature for people who cannot see or read a screen
- ensuring content is checked for compatibility with well known computer software screen-readers

## Sources and References

- British Standard BS 8300: 'Design of buildings and their approaches to meet the needs of disabled people', BSI 2001
- Planning and Access for Disabled People: 'A Good Practice Guide', ODPM: March 2003
- 'Designing For Accessibility' Supplementary Planning Guidance, London Borough of Croydon: March 2000
- Building Regulations 2000 - Part M: 'Access to and Use of Buildings', ODPM: May 2004 Edition
- 'Sign Design Guide', JMU Access Partnership and Sign Design Society: 2001
- Planning Policy Guidance Note 17: Planning for Open Space, Sport and Recreation, Department of the Environment, Transport and the Regions: 2002
- 'Access for Disabled People', Sport England: 2002
- 'Easy Access to Historic Properties', English Heritage: 1995
- 'Making Access to Goods and Services Easier for Disabled Customers. A Practical Guide for Small Businesses and Other Small Service Providers', Disability Rights Commission: 2002
- The Mayor of London's, 'London Plan: Spatial Development Strategy for Greater London': Greater London Authority: February 2004
- Accessible London: Achieving an Inclusive Environment, The London Plan Supplementary Planning Guidance, Mayor of London: 2004
- Buildings for All to Use - Improving the Accessibility of Public Buildings and Environments (C610) by K Bright, S Flanagan, J Embleton, L Selbekk, G Cook: 2004, ISBN: 0-86017-610-X
- Designing an Accessible City: Corporation of London: 1998
- Designing for the Disabled by Selwyn Goldsmith: October 1967, RIBA Publications, ISBN: 0900630272
- A Good Practice Guide to Disabled People's Access in the Countryside, BT Countryside For All Standards and Guidelines
- Developing Accessible Play Space, Office of the Deputy Prime Minister: 2003, Product code 03UPU01737
- Access and Inclusion: A Management Guide published by Croner